



# DashCommand

## CALC & CONST PID Reference

Revision 1 - July 13, 2010

### Table Of Contents

CALC & CONST PID Index - Alphabetical

CALC & CONST PID Index – By Category

Airflow

Distance

Emissions

Environment

Fuel

General

Performance

Speed

System

Time

Transmission

CALC PID Reference

CONST PID Reference

Legend

## Legend

Parameter ID (PID)	PID description	English units	Metric units	Category	Priority
<b>CALC.ACCELERATION</b>	Current acceleration based on vehicle speed	<b>E:</b> ft/s <sup>2</sup>	<b>M:</b> m/s <sup>2</sup>	Performance	P1

### Certain units are controlled by Unit Settings

- 1** Output unit is controlled by the 'Boost pressure' unit setting
- 2** Output unit is controlled by the 'Torque' unit setting
- 3** Output unit is controlled by the 'Volume' unit setting
- 4** Output unit is controlled by the 'Power' unit setting

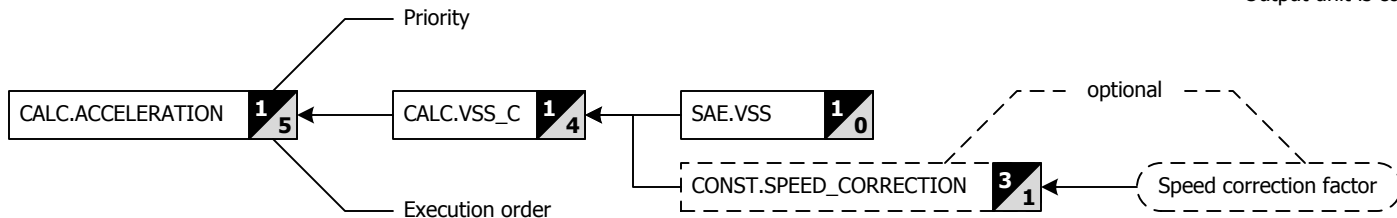

CALC.ACCELERATION depends on values from CALC.VSS\_C which, in turn, depends on values from SAE.VSS and CONST.SPEED\_CORRECTION. CONST.SPEED\_CORRECTION takes its values from the vehicle setting 'Speed correction factor'.

## CALC & CONST PID Index - Alphabetical

<b>CALC.ACCELERATION</b>	Current acceleration based on vehicle speed	<b>E:</b> ft/s <sup>2</sup>	<b>M:</b> m/s <sup>2</sup>	Performance	P1
<b>CALC.ACCELERATION_G</b>	Current acceleration expressed as a unit of gravity	<b>E:</b> g	<b>M:</b> g	Performance	P1
<b>CALC.AFR_ACTUAL</b>	Air/fuel ratio calculated from actual lambda	<b>E:</b> --	<b>M:</b> --	Fuel	P1
<b>CALC.AFR_CMDANDED</b>	Air/fuel ration from commanded lambda	<b>E:</b> --	<b>M:</b> --	Fuel	P1
<b>CALC.AIR_DENSITY</b>	Ambient air density	<b>E:</b> lb/ft <sup>3</sup>	<b>M:</b> kg/m <sup>3</sup>	Environment	P2
<b>CALC.BOOST_PRESSURE</b>	Boost pressure estimation	<b>E:</b> psi	<b>M:</b> kPa   bar   kg-f/cm <sup>2</sup>	1 Airflow	P1
<b>CALC.DISTANCE</b>	Distance travelled since last fuel consumption dashboard reset	<b>E:</b> miles	<b>M:</b> km	Distance	P1
<b>CALC.DTE</b>	Distance to empty	<b>E:</b> miles	<b>M:</b> km	Fuel	P1
<b>CALC.ENGINE_POWER</b>	Calculated engine power output at wheels	<b>E:</b> hp	<b>M:</b> kW   ps	4 Performance	P1
<b>CALC.ENGINE_TORQUE</b>	Calculated engine torque at the wheels	<b>E:</b> lb-ft	<b>M:</b> N·m   kg-f·m	2 Performance	P1
<b>CALC.FC.AFC</b>	Average fuel economy/consumption for past periods of time	<b>E:</b> mpg(US)   mpg(UK)	<b>M:</b> l/100km	3 System	P1
<b>CALC.FC.AFC.{01..17}</b>	Average fuel economy/consumption for period 01 to 17	<b>E:</b> mpg(US)   mpg(UK)	<b>M:</b> l/100km	3 Fuel	P1
<b>CALC.FC.AVERAGE</b>	Average fuel economy since last fuel dashboard reset	<b>E:</b> mpg(US)   mpg(UK)	<b>M:</b> l/100km	3 Fuel	P1
<b>CALC.FC.FUEL_VOLUME</b>	Volume of fuel consumed since last fuel dashboard reset	<b>E:</b> gal(US)   gal(UK)	<b>M:</b> l	3 Fuel	P1
<b>CALC.FC.IFC</b>	Instantaneous fuel economy/consumption	<b>E:</b> mpg(US)   mpg(UK)	<b>M:</b> l/100km	3 Fuel	P1
<b>CALC.FC.IFC_AVG</b>	Average instantaneous fuel economy/consumption	<b>E:</b> mpg(US)   mpg(UK)	<b>M:</b> l/100km	3 Fuel	P1
<b>CALC.FILLUP</b>	Manages the values displayed on Fillup dashboard	<b>E:</b> --	<b>M:</b> --	System	P1
<b>CALC.FILLUP.CORRECTION</b>	Fuel consumption correction factor obtained form Fillup dashboard	<b>E:</b> %	<b>M:</b> coefficient	Fuel	P1
<b>CALC.FILLUP.FUEL_PRICE</b>	Fuel price entered at last fill up	<b>E:</b> cur (input)	<b>M:</b> cur (blended)	Fuel	P1
<b>CALC.FILLUP.FUEL_USED</b>	Volume of fuel used since last fillup	<b>E:</b> gal(US)   gal(UK)	<b>M:</b> l	3 Fuel	P1
<b>CALC.FRP</b>	Fuel rail pressure	<b>E:</b> psi	<b>M:</b> kPa	Fuel	P1
<b>CALC.FUEL_CONSUMPTION</b>	Collection of fuel economy/consumption CALC PIDs	<b>E:</b> --	<b>M:</b> --	System	P3
<b>CALC.FUEL_FLOW</b>	Fuel flow rate derived from mass air flow	<b>E:</b> gal(US)/h   gal(UK)/h	<b>M:</b> l/h	3 Fuel	P1
<b>CALC.FUEL_FLOW_AVG</b>	Average fuel flow rate derived from mass air flow	<b>E:</b> gal(US)/h   gal(UK)/h	<b>M:</b> l/h	3 Fuel	P1
<b>CALC.FUEL_LEVEL</b>	Volume of fuel remaining in fuel tank	<b>E:</b> gal(US)   gal(UK)	<b>M:</b> l	3 Fuel	P1
<b>CALC.GEAR</b>	Gear related calculations	<b>E:</b> --	<b>M:</b> --	System	P1
<b>CALC.GEAR.CURRENT</b>	Currently engaged gear	<b>E:</b> --	<b>M:</b> --	Transmission	P1
<b>CALC.GEAR.NUM_GEAR</b>	Number of gears	<b>E:</b> --	<b>M:</b> --	Transmission	P3
<b>CALC.GEAR.SHIFT_INDICATOR</b>	Indicates that a shift is suggested and in which direction	<b>E:</b> --	<b>M:</b> --	Transmission	P1
<b>CALC.GEAR.SUGGESTED</b>	Suggested gear to best match the current speed	<b>E:</b> --	<b>M:</b> --	Transmission	P1
<b>CALC.IS_NEW_DAY</b>	Returns true when a new day starts	<b>E:</b> --	<b>M:</b> --	Time	P3
<b>CALC.LAMBDA_ACTUAL</b>	Actual lambda read from a wideband oxygen sensor	<b>E:</b> --	<b>M:</b> --	Fuel	P1
<b>CALC.LAMBDA_CMDANDED</b>	Commanded lambda as directed by ECU	<b>E:</b> --	<b>M:</b> --	System	P1
<b>CALC.MAF</b>	Mass air flow – uses best possible calculation method	<b>E:</b> lb/min	<b>M:</b> g/s	Airflow	P1
<b>CALC.MAF_A</b>	Mass air flow – Method A (LOAD_ABS+RPM)	<b>E:</b> lb/min	<b>M:</b> g/s	Airflow	P1
<b>CALC.MAF_B</b>	Mass air flow – Method B (MAP+RPM+IAT)	<b>E:</b> lb/min	<b>M:</b> g/s	Airflow	P1
<b>CALC.MAP</b>	Manifold absolute pressure – uses best possible calculation method	<b>E:</b> inHg	<b>M:</b> kPa	Airflow	P1
<b>CALC.MAP_A</b>	Manifold absolute pressure – Method A (MAF+RPM+IAT)	<b>E:</b> inHg	<b>M:</b> kPa	Airflow	P1
<b>CALC.MAP_B</b>	Manifold absolute pressure – Method B (LOAD_ABS+RPM+IAT)	<b>E:</b> inHg	<b>M:</b> kPa	Airflow	P1
<b>CALC.TRIP</b>	Collection of all the Trip Computer CALC PIDs	<b>E:</b> --	<b>M:</b> --	System	P3
<b>CALC.TRIP.ACCEL</b>	Acceleration stats for trip computer	<b>E:</b> --	<b>M:</b> --	System	P1
<b>CALC.TRIP.ACCEL.BRAKING.MAX.{ABTPF}</b>	Maximum braking acceleration for trips A, B, T, P, and F	<b>E:</b> g	<b>M:</b> g	Performance	P3
<b>CALC.TRIP.ACCEL.FORWARD.MAX.{ABTPF}</b>	Maximum forward acceleration for trips A, B, T, P, and F	<b>E:</b> g	<b>M:</b> g	Performance	P3
<b>CALC.TRIP.AFC</b>	Average fuel consumption stats for trip computer	<b>E:</b> --	<b>M:</b> --	System	P1
<b>CALC.TRIP.AFC.{ABTPF}</b>	Average fuel consumption for trips A, B, T, P, and F	<b>E:</b> mpg(US)   mpg(UK)	<b>M:</b> l/100km	3 Fuel	P3
<b>CALC.TRIP.BOOST</b>	Boost pressure stats for the trip computer	<b>E:</b> --	<b>M:</b> --	System	P1
<b>CALC.TRIP.BOOST.AVG.{ABTPF}</b>	Average boost pressure for trips A, B, T, P, and F	<b>E:</b> psi	<b>M:</b> kPa   bar   kg-f/cm <sup>2</sup>	1 Airflow	P3
<b>CALC.TRIP.BOOST.MAX_BOOST.{ABTPF}</b>	Maximum boost pressure for trips A, B, T, P, and F	<b>E:</b> psi	<b>M:</b> kPa   bar   kg-f/cm <sup>2</sup>	1 Airflow	P3
<b>CALC.TRIP.CO2</b>	Carbon dioxide (CO2) emissions stats for the trip computer	<b>E:</b> --	<b>M:</b> --	System	P1
<b>CALC.TRIP.CO2.RATE.{ABTPF}</b>	Average carbon dioxide emission rate for trip A, B, T, P, and F	<b>E:</b> oz/mi	<b>M:</b> g/km	Emissions	P3
<b>CALC.TRIP.CO2.TOTAL.{ABTPF}</b>	Total carbon dioxide emission for trip A, B, T, P, and F	<b>E:</b> lb	<b>M:</b> kg	Emissions	P3
<b>CALC.TRIP.DISTANCE</b>	Distance stats for trip computer	<b>E:</b> --	<b>M:</b> --	System	P1
<b>CALC.TRIP.DISTANCE.{ABTPF}</b>	Distance travelled for trip A, B, T, P, and F	<b>E:</b> miles	<b>M:</b> km	Distance	P3
<b>CALC.TRIP.FILLUPS</b>	Fill up stats for trip computer	<b>E:</b> --	<b>M:</b> --	System	P1
<b>CALC.TRIP.FILLUPS.{ABTPF}</b>	Number of fill ups for trip A, B, T, P, and F	<b>E:</b> --	<b>M:</b> --	Fuel	P3
<b>CALC.TRIP.FUEL_COST</b>	Fuel cost stats for trip computer	<b>E:</b> --	<b>M:</b> --	System	P1
<b>CALC.TRIP.FUEL_COST.{ABTPF}</b>	Cost of fuel consumed for trip A, B, T, P, and F	<b>E:</b> currency	<b>M:</b> currency	Fuel	P3
<b>CALC.TRIP.FUEL_FLOW</b>	Fuel flow stats for trip computer	<b>E:</b> --	<b>M:</b> --	System	P1
<b>CALC.TRIP.FUEL_FLOW.AVG.{ABTPF}</b>	Average fuel flow rate for trip A, B, T, P, and F	<b>E:</b> gal(US)/h   gal(UK)/h	<b>M:</b> l/h	3 Fuel	P3
<b>CALC.TRIP.FUEL_FLOW.MAX.{ABTPF}</b>	Maximum fuel flow rate for trip A, B, T, P, and F	<b>E:</b> gal(US)/h   gal(UK)/h	<b>M:</b> l/h	3 Fuel	P3
<b>CALC.TRIP.FUEL_USED</b>	Fuel consumption stats for trip computer	<b>E:</b> --	<b>M:</b> --	System	P1
<b>CALC.TRIP.FUEL_USED.{ABTPF}</b>	Fuel consumed in trip A, B, T, P, and F	<b>E:</b> gal(US)   gal(UK)	<b>M:</b> l	3 Fuel	P3
<b>CALC.TRIP.GEAR</b>	Gear stats for trip computer	<b>E:</b> --	<b>M:</b> --	System	P1
<b>CALC.TRIP.GEAR.{1..6}.DISTANCE_PCT.{ABTPF}</b>	Percent distance travelled in each gear for trip A, B, T, P, and F	<b>E:</b> %	<b>M:</b> %	Transmission	P3
<b>CALC.TRIP.GEAR.{1..6}.TIME_PCT.{ABTPF}</b>	Percent time travelled in each gear for trip A, B, T, P, and F	<b>E:</b> %	<b>M:</b> %	Transmission	P3
<b>CALC.TRIP.GEAR.N.DISTANCE_PCT.{ABTPF}</b>	Percent distance travelled in no gear for trip A, B, T, P, and F	<b>E:</b> %	<b>M:</b> %	Transmission	P3
<b>CALC.TRIP.GEAR.N.TIME_PCT.{ABTPF}</b>	Percent time travelled in no gear for trip A, B, T, P, and F	<b>E:</b> %	<b>M:</b> %	Transmission	P3
<b>CALC.TRIP.GEAR.WG.DISTANCE_PCT.{ABTPF}</b>	Percent distance travelled in wrong gear for trip A, B, T, P, and F	<b>E:</b> %	<b>M:</b> %	Transmission	P3
<b>CALC.TRIP.GEAR.WG.TIME_PCT.{ABTPF}</b>	Percent time travelled in wrong gear for trip A, B, T, P, and F	<b>E:</b> %	<b>M:</b> %	Transmission	P3
<b>CALC.TRIP.POWER</b>	Engine power stats for trip computer	<b>E:</b> --	<b>M:</b> --	System	P1
<b>CALC.TRIP.POWER.MAX.{ABTPF}</b>	Maximum engine power for trip A, B, T, P, and F	<b>E:</b> hp	<b>M:</b> kW   ps	4 Performance	P3
<b>CALC.TRIP.RPM</b>	Engine speed stats for trip computer	<b>E:</b> --	<b>M:</b> --	System	P1
<b>CALC.TRIP.RPM.AVG.{ABTPF}</b>	Average engine speed for trips A, B, T, P, and F	<b>E:</b> rpm	<b>M:</b> r/min	Speed	P3
<b>CALC.TRIP.RPM.MAX.{ABTPF}</b>	Maximum engine speed for trips A, B, T, P, and F	<b>E:</b> rpm	<b>M:</b> r/min	Speed	P3
<b>CALC.TRIP.SPEED</b>	Vehicle speed stats for the trip computer	<b>E:</b> --	<b>M:</b> --	System	P1
<b>CALC.TRIP.SPEED.AVG_NI.{ABTPF}</b>	Average vehicle speed (no idling) for trips A, B, T, P, and F	<b>E:</b> mph	<b>M:</b> km/h	Speed	P3
<b>CALC.TRIP.SPEED.AVG_WI.{ABTPF}</b>	Average vehicle speed (with idling) for trips A, B, T, P, and F	<b>E:</b> mph	<b>M:</b> km/h	Speed	P3
<b>CALC.TRIP.SPEED.MAX.{ABTPF}</b>	Maximum vehicle speed for trips A, B, T, P, and F	<b>E:</b> mph	<b>M:</b> km/h	Speed	P3
<b>CALC.TRIP.STOPS</b>	Number of stops stats for the trip computer	<b>E:</b> --	<b>M:</b> --	System	P1
<b>CALC.TRIP.STOPS.{ABTPF}</b>	Number of stops for trips A, B, T, P, and F	<b>E:</b> --	<b>M:</b> --	General	P3
<b>CALC.TRIP.TIME</b>	Time based stats for the trip computer	<b>E:</b> --	<b>M:</b> --	System	P1
<b>CALC.TRIP.TIME.DRIVE.{ABTPF}</b>	Drive time for trips A, B, T, P, and F	<b>E:</b> hh:mm	<b>M:</b> ms	Time	P3
<b>CALC.TRIP.TIME.ELAPSED.{ABTPF}</b>	Elapsed time for trips A, B, T, P, and F	<b>E:</b> hh:mm	<b>M:</b> ms	Time	P3
<b>CALC.TRIP.TIME.IDLE.{ABTPF}</b>	Idle time for trips A, B, T, P, and F	<b>E:</b> hh:mm	<b>M:</b> ms	Time	P3
<b>CALC.TRIP.TIME.RUN.{ABTPF}</b>	Run time for trips A, B, T, P, and F	<b>E:</b> hh:mm	<b>M:</b> ms	Time	P3
<b>CALC.TRIP.TIME.START.{ABTPF}</b>	Start time for trips A, B, T, P, and F	<b>E:</b> hh:mm	<b>M:</b> ms	Time	P3
<b>CALC.TRIP.TORQUE</b>	Engine torque stats for the trip computer	<b>E:</b> --	<b>M:</b> --	System	P1
<b>CALC.TRIP.TORQUE.MAX.{ABTPF}</b>	Maximum engine torque for trips A, B, T, P, and F	<b>E:</b> lb-ft	<b>M:</b> N·m   kg-f·m	2 Performance	P3
<b>CALC.TTE</b>	Time to empty	<b>E:</b> hh:mm	<b>M:</b> hh:mm	Fuel	P1
<b>CALC.VACUUM</b>	Intake vacuum pressure	<b>E:</b> inHg	<b>M:</b> kPa	Airflow	P1
<b>CALC.VSS_C</b>	Corrected vehicle speed	<b>E:</b> mph	<b>M:</b> km/h	Speed	P1
<b>CALC.VSS_D</b>	Vehicle speed derived from RPM (experimental)	<b>E:</b> mph	<b>M:</b> km/h	Speed	P1
<b>CONST.ADDITIONAL_WEIGHT</b>	Validated 'Additional weight' setting	<b>E:</b> lb	<b>M:</b> kg	System	P3
<b>CONST.CURB_WEIGHT</b>	Validated 'Curb weight' setting	<b>E:</b> lb	<b>M:</b> kg	System	P3
<b>CONST.DRAG_COEFFICIENT</b>	Validated 'Drag coefficient' setting	<b>E:</b> --	<b>M:</b> --	System	P3
<b>CONST.ENGINE_DISPLACEMENT</b>	Validate 'Engine displacement' setting	<b>E:</b> in <sup>3</sup>	<b>M:</b> l	System	P3
<b>CONST.FINAL_DRIVE_RATIOS</b>	Validated 'Final drive ratios' setting	<b>E:</b> --	<b>M:</b> --	System	P3
<b>CONST.FRONTAL_AREA</b>	Validated 'Frontal area' setting	<b>E:</b> ft <sup>2</sup>	<b>M:</b> m <sup>2</sup>	System	P3
<b>CONST.FRP_PID</b>	Fuel rail pressure PID used by the system	<b>E:</b> --	<b>M:</b> --	System	P3
<b>CONST.FUEL_CO2_CONTENT</b>	Carbon dioxide content for current fuel type	<b>E:</b> lb/gal(US)   lb/gal(UK)	<b>M:</b> kg/l	3 System	P3
<b>CONST.FUEL_DENSITY</b>	Fuel density of current fuel type	<b>E:</b> lb/gal(US)   lb/gal(UK)	<b>M:</b> g/l	3 System	P3
<b>CONST.FUEL_TANK_CAPACITY</b>	Validated 'Fuel tank capacity' setting	<b>E:</b> gal(US)   gal(UK)	<b>M:</b> l	3 System	P3
<b>CONST.LAMBDA_ACTUAL_PID</b>	Lambda PID used by the system	<b>E:</b> --	<b>M:</b> --	System	P3
<b>CONST.LAMBDA_CMDANDED_PID</b>	Commanded Lambda PID used by the system	<b>E:</b> --	<b>M:</b> --	System	P3
<b>CONST.MAF_PID</b>	Mass air flow PID used by the system	<b>E:</b> --	<b>M:</b> --	System	P3
<b>CONST.MAP_PID</b>	Manifold absolute pressure PID used by the system	<b>E:</b> --	<b>M:</b> --	System	P3
<b>CONST.MAX_RPM</b>	Validated 'Maximum engine speed' setting	<b>E:</b> rpm	<b>M:</b> r/min	System	P3
<b>CONST.MIN_RPM</b>	Validated 'Minimum engine speed' setting	<b>E:</b> rpm	<b>M:</b> r/min	System	P3
<b>CONST.SHIFT_RPM</b>	Validated 'Shift point' setting	<b>E:</b> rpm	<b>M:</b> r/min	System	P3
<b>CONST.SPEED_CORRECTION</b>	Validated 'Speed correction factor' setting	<b>E:</b> %	<b>M:</b> coefficient	System	P3
<b>CONST.SPEED_ZONES</b>	Speed zones for shift dashboard	<b>E:</b> --	<b>M:</b> --	System	P3
<b>CONST.SPEED_ZONES.{1..6}.MAX_SPEED</b>	Maximum speed for each gear	<b>E:</b> mph	<b>M:</b> km/h	System	P3
<b>CONST.SPEED_ZONES.{1..6}.MIN_SPEED</b>	Minimum speed for each gear	<b>E:</b> mph	<b>M:</b> km/h	System	P3
<b>CONST.SPEED_ZONES.{1..6}.SHIFT_SPEED</b>	Ideal shift speed for each gear	<b>E:</b> mph	<b>M:</b> km/h	System	P3
<b>CONST.STOICHIOMETRIC_AIR_FUEL_RATIO</b>	Stoichiometric air/fuel ratio of current fuel type	<b>E:</b> --	<b>M:</b> --	System	P3
<b>CONST.TIRE_RESISTANCE</b>	Validated 'Tire rolling resistance coefficient' setting	<b>E:</b> --	<b>M:</b> --	System	P3
<b>CONST.VOLUMETRIC_EFFICIENCY</b>	Validated 'Volumetric efficiency' setting	<b>E:</b> %	<b>M:</b> coefficient	System	P3
<b>CONST.WHEEL_CIRCUMFERENCE</b>	Wheel circumference used by the system	<b>E:</b> r/mile	<b>M:</b> r/km	System	P3

## CALC & CONST PID Index – By Category

Airflow					
CALC.BOOST_PRESSURE	Boost pressure estimation	E: psi	M: kPa   bar   kg-f/cm <sup>2</sup>	<sup>1</sup> Airflow	P1
CALC.MAF	Mass air flow – uses best possible calculation method	E: lb/min	M: g/s	Airflow	P1
CALC.MAF_A	Mass air flow – Method A (LOAD_ABS+RPM)	E: lb/min	M: g/s	Airflow	P1
CALC.MAF_B	Mass air flow – Method B (MAP+RPM+IAT)	E: lb/min	M: g/s	Airflow	P1
CALC.MAP	Manifold absolute pressure – uses best possible calculation method	E: inHg	M: kPa	Airflow	P1
CALC.MAP_A	Manifold absolute pressure – Method A (MAF+RPM+IAT)	E: inHg	M: kPa	Airflow	P1
CALC.MAP_B	Manifold absolute pressure – Method B (LOAD_ABS+RPM+IAT)	E: inHg	M: kPa	Airflow	P1
CALC.TRIP.BOOST.AVG.{ABTPF}	Average boost pressure for trips A, B, T, P, and F	E: psi	M: kPa   bar   kg-f/cm <sup>2</sup>	<sup>1</sup> Airflow	P3
CALC.TRIP.BOOST.MAX_BOOST.{ABTPF}	Maximum boost pressure for trips A, B, T, P, and F	E: psi	M: kPa   bar   kg-f/cm <sup>2</sup>	<sup>1</sup> Airflow	P3
CALC.VACUUM	Intake vacuum pressure	E: inHg	M: kPa	Airflow	P1
Distance					
CALC.DISTANCE	Distance travelled since last fuel consumption dashboard reset	E: miles	M: km	Distance	P1
CALC.TRIP.DISTANCE.{ABTPF}	Distance travelled for trip A, B, T, P, and F	E: miles	M: km	Distance	P3
Emissions					
CALC.TRIP.CO2.RATE.{ABTPF}	Average carbon dioxide emission rate for trip A, B, T, P, and F	E: oz/mi	M: g/km	Emissions	P3
CALC.TRIP.CO2.TOTAL.{ABTPF}	Total carbon dioxide emission for trip A, B, T, P, and F	E: lb	M: kg	Emissions	P3
Environment					
CALC.AIR_DENSITY	Ambient air density	E: lb/ft <sup>3</sup>	M: kg/m <sup>3</sup>	Environment	P2
Fuel					
CALC.AFR_ACTUAL	Air/fuel ratio calculated from actual lambda	E: --	M: --	Fuel	P1
CALC.AFR_COMMANDED	Air/fuel ration from commanded lambda	E: --	M: --	Fuel	P1
CALC.DTE	Distance to empty	E: miles	M: km	Fuel	P1
CALC.FC.AFC.{01..17}	Average fuel economy/consumption for period 01 to 17	E: mpg(US)   mpg(UK)	M: l/100km	Fuel	P1
CALC.FC.AVERAGE	Average fuel economy since last fuel dashboard reset	E: mpg(US)   mpg(UK)	M: l/100km	Fuel	P1
CALC.FC.FUEL_VOLUME	Volume of fuel consumed since last fuel dashboard reset	E: gal(US)   gal(UK)	M: l	Fuel	P1
CALC.FC.IFC	Instantaneous fuel economy/consumption	E: mpg(US)   mpg(UK)	M: l/100km	Fuel	P1
CALC.FC.IFC_AVG	Average instantaneous fuel economy/consumption	E: mpg(US)   mpg(UK)	M: l/100km	Fuel	P1
CALC.FILLUP.CORRECTION	Fuel consumption correction factor obtained form Fillup dashboard	E: %	M: coefficient	Fuel	P1
CALC.FILLUP.FUEL_PRICE	Fuel price entered at last fill up	E: cur (input)	M: cur (blended)	Fuel	P1
CALC.FILLUP.FUEL_USED	Volume of fuel used since last fillup	E: gal(US)   gal(UK)	M: l	Fuel	P1
CALC.FRP	Fuel rail pressure	E: psi	M: kPa	Fuel	P1
CALC.FUEL_FLOW	Fuel flow rate derived from mass air flow	E: gal(US)/h   gal(UK)/h	M: l/h	Fuel	P1
CALC.FUEL_FLOW_AVG	Average fuel flow rate derived from mass air flow	E: gal(US)/h   gal(UK)/h	M: l/h	Fuel	P1
CALC.FUEL_LEVEL	Volume of fuel remaining in fuel tank	E: gal(US)   gal(UK)	M: l	Fuel	P1
CALC.LAMBDA_ACTUAL	Actual lambda read from a wideband oxygen sensor	E: --	M: --	Fuel	P1
CALC.TRIP.AFC.{ABTPF}	Average fuel consumption for trips A, B, T, P, and F	E: mpg(US)   mpg(UK)	M: l/100km	Fuel	P3
CALC.TRIP.FILLUPS.{ABTPF}	Number of fill ups for trip A, B, T, P, and F	E: --	M: --	Fuel	P3
CALC.TRIP.FUEL_COST.{ABTPF}	Cost of fuel consumed for trip A, B, T, P, and F	E: currency	M: currency	Fuel	P3
CALC.TRIP.FUEL_FLOW.AVG.{ABTPF}	Average fuel flow rate for trip A, B, T, P, and F	E: gal(US)/h   gal(UK)/h	M: l/h	Fuel	P3
CALC.TRIP.FUEL_FLOW.MAX.{ABTPF}	Maximum fuel flow rate for trip A, B, T, P, and F	E: gal(US)/h   gal(UK)/h	M: l/h	Fuel	P3
CALC.TRIP.FUEL_USED.{ABTPF}	Fuel consumed in trip A, B, T, P, and F	E: gal(US)   gal(UK)	M: l	Fuel	P3
CALC.TTE	Time to empty	E: hh:mm	M: hh:mm	Fuel	P1
General					
CALC.TRIP.STOPS.{ABTPF}	Number of stops for trips A, B, T, P, and F	E: --	M: --	General	P3
Performance					
CALC.ACCELERATION	Current acceleration based on vehicle speed	E: ft/s <sup>2</sup>	M: m/s <sup>2</sup>	Performance	P1
CALC.ACCELERATION_G	Current acceleration expressed as a unit of gravity	E: g	M: g	Performance	P1
CALC.ENGINE_POWER	Calculated engine power output at wheels	E: hp	M: kW   ps	<sup>4</sup> Performance	P1
CALC.ENGINE_TORQUE	Calculated engine torque at the wheels	E: lb-ft	M: N·m   kg-f·m	<sup>2</sup> Performance	P1
CALC.TRIP.ACCEL.BRAKING.MAX.{ABTPF}	Maximum braking acceleration for trips A, B, T, P, and F	E: g	M: g	Performance	P3
CALC.TRIP.ACCEL.FORWARD.MAX.{ABTPF}	Maximum forward acceleration for trips A, B, T, P, and F	E: g	M: g	Performance	P3
CALC.TRIP.POWER.MAX.{ABTPF}	Maximum engine power for trip A, B, T, P, and F	E: hp	M: kW   ps	<sup>4</sup> Performance	P3
CALC.TRIP.TORQUE.MAX.{ABTPF}	Maximum engine torque for trips A, B, T, P, and F	E: lb-ft	M: N·m   kg-f·m	<sup>2</sup> Performance	P3
Speed					
CALC.TRIP.RPM.AVG.{ABTPF}	Average engine speed for trips A, B, T, P, and F	E: rpm	M: r/min	Speed	P3
CALC.TRIP.RPM.MAX.{ABTPF}	Maximum engine speed for trips A, B, T, P, and F	E: rpm	M: r/min	Speed	P3
CALC.TRIP.SPEED.AVG_NI.{ABTPF}	Average vehicle speed (no idling) for trips A, B, T, P, and F	E: mph	M: km/h	Speed	P3
CALC.TRIP.SPEED.AVG_WI.{ABTPF}	Average vehicle speed (with idling) for trips A, B, T, P, and F	E: mph	M: km/h	Speed	P3
CALC.TRIP.SPEED.MAX.{ABTPF}	Maximum vehicle speed for trips A, B, T, P, and F	E: mph	M: km/h	Speed	P3
CALC.VSS_C	Corrected vehicle speed	E: mph	M: km/h	Speed	P1
CALC.VSS_D	Vehicle speed derived from RPM (experimental)	E: mph	M: km/h	Speed	P1
System					
CALC.FC.AFC	Average fuel economy/consumption for past periods of time	E: mpg(US)   mpg(UK)	M: l/100km	System	P1
CALC.FILLUP	Manages the values displayed on Fillup dashboard	E: --	M: --	System	P1
CALC.FUEL_CONSUMPTION	Collection of fuel economy/consumption CALC PIDs	E: --	M: --	System	P3
CALC.GEAR	Gear related calculations	E: --	M: --	System	P1
CALC.LAMBDA_COMMANDED	Commanded lambda as directed by ECU	E: --	M: --	System	P1
CALC.TRIP	Collection of all the Trip Computer CALC PIDs	E: --	M: --	System	P3
CALC.TRIP.ACCEL	Acceleration stats for trip computer	E: --	M: --	System	P1
CALC.TRIP.AFC	Average fuel consumption stats for trip computer	E: --	M: --	System	P1
CALC.TRIP.BOOST	Boost pressure stats for the trip computer	E: --	M: --	System	P1
CALC.TRIP.CO2	Carbon dioxide (CO2) emissions stats for the trip computer	E: --	M: --	System	P1
CALC.TRIP.DISTANCE	Distance stats for trip computer	E: --	M: --	System	P1
CALC.TRIP.FILLUPS	Fill up stats for trip computer	E: --	M: --	System	P1
CALC.TRIP.FUEL_COST	Fuel cost stats for trip computer	E: --	M: --	System	P1
CALC.TRIP.FUEL_FLOW	Fuel flow stats for trip computer	E: --	M: --	System	P1
CALC.TRIP.FUEL_USED	Fuel consumption stats for trip computer	E: --	M: --	System	P1
CALC.TRIP.GEAR	Gear stats for trip computer	E: --	M: --	System	P1
CALC.TRIP.POWER	Engine power stats for trip computer	E: --	M: --	System	P1
CALC.TRIP.RPM	Engine speed stats for trip computer	E: --	M: --	System	P1
CALC.TRIP.SPEED	Vehicle speed stats for the trip computer	E: --	M: --	System	P1
CALC.TRIP.STOPS	Number of stops stats for the trip computer	E: --	M: --	System	P1
CALC.TRIP.TIME	Time based stats for the trip computer	E: --	M: --	System	P1
CALC.TRIP.TORQUE	Engine torque stats for the trip computer	E: --	M: --	System	P1
CONST.ADDITIONAL_WEIGHT	Validated 'Additional weight' setting	E: lb	M: kg	System	P3
CONST.CURB_WEIGHT	Validated 'Curb weight' setting	E: lb	M: kg	System	P3
CONST.DRAG_COEFFICIENT	Validated 'Drag coefficient' setting	E: --	M: --	System	P3
CONST.ENGINE_DISPLACEMENT	Validate 'Engine displacement' setting	E: in <sup>3</sup>	M: l	System	P3
CONST.FINAL_DRIVE_RATIOS	Validated 'Final drive ratios' setting	E: --	M: --	System	P3
CONST.FRONTAL_AREA	Validated 'Frontal area' setting	E: ft <sup>2</sup>	M: m <sup>2</sup>	System	P3
CONST.FRP_PID	Fuel rail pressure PID used by the system	E: --	M: --	System	P3
CONST.FUEL_CO2_CONTENT	Carbon dioxide content for current fuel type	E: lb/gal(US)   lb/gal(UK)	M: kg/l	System	P3
CONST.FUEL_DENSITY	Fuel density of current fuel type	E: lb/gal(US)   lb/gal(UK)	M: g/l	System	P3
CONST.FUEL_TANK_CAPACITY	Validated 'Fuel tank capacity' setting	E: gal(US)   gal(UK)	M: l	System	P3
CONST.LAMBDA_ACTUAL_PID	Lambda PID used by the system	E: --	M: --	System	P3
CONST.LAMBDA_COMMANDED_PID	Commanded Lambda PID used by the system	E: --	M: --	System	P3
CONST.MAF_PID	Mass air flow PID used by the system	E: --	M: --	System	P3
CONST.MAP_PID	Manifold absolute pressure PID used by the system	E: --	M: --	System	P3
CONST.MAX_RPM	Validated 'Maximum engine speed' setting	E: rpm	M: r/min	System	P3
CONST.MIN_RPM	Validated 'Minimum engine speed' setting	E: rpm	M: r/min	System	P3
CONST.SHIFT_RPM	Validated 'Shift point' setting	E: rpm	M: r/min	System	P3
CONST.SPEED_CORRECTION	Validated 'Speed correction factor' setting	E: %	M: coefficient	System	P3
CONST.SPEED_ZONES	Speed zones for shift dashboard	E: --	M: --	System	P3
CONST.SPEED_ZONES.{1..6}.MAX_SPEED	Maximum speed for each gear	E: mph	M: km/h	System	P3
CONST.SPEED_ZONES.{1..6}.MIN_SPEED	Minimum speed for each gear	E: mph	M: km/h	System	P3
CONST.SPEED_ZONES.{1..6}.SHIFT_SPEED	Ideal shift speed for each gear	E: mph	M: km/h	System	P3
CONST.STOICHIOMETRIC_AIR_FUEL_RATIO	Stoichiometric air/fuel ratio of current fuel type	E: --	M: --	System	P3
CONST.TIRE_RESISTANCE	Validated 'Tire rolling resistance coefficient' setting	E: --	M: --	System	P3
CONST.VOLUMETRIC_EFFICIENCY	Validated 'Volumetric efficiency' setting	E: %	M: coefficient	System	P3
CONST.WHEEL_CIRCUMFERENCE	Wheel circumference used by the system	E: r/mile	M: r/km	System	P3
Time					
CALC.IS_NEW_DAY	Returns true when a new day starts	E: --	M: --	Time	P3
CALC.TRIP.TIME.DRIVE.{ABTPF}	Drive time for trips A, B, T, P, and F	E: hh:mm	M: ms	Time	P3
CALC.TRIP.TIME.ELAPSED.{ABTPF}	Elapsed time for trips A, B, T, P, and F	E: hh:mm	M: ms	Time	P3
CALC.TRIP.TIME.IDLE.{ABTPF}	Idle time for trips A, B, T, P, and F	E: hh:mm	M: ms	Time	P3
CALC.TRIP.TIME.RUN.{ABTPF}	Run time for trips A, B, T, P, and F	E: hh:mm	M: ms	Time	P3
CALC.TRIP.TIME.START.{ABTPF}	Start time for trips A, B, T, P, and F	E: hh:mm	M: ms	Time	P3
Transmission					
CALC.GEAR.CURRENT	Currently engaged gear	E: --	M: --	Transmission	P1
CALC.GEAR.NUM_GEAR	Number of gears	E: --	M: --	Transmission	P3
CALC.GEAR.SHIFT_INDICATOR	Indicates that a shift is suggested and in which direction	E: --	M: --	Transmission	P1
CALC.GEAR.SUGGESTED	Suggested gear to best match the current speed	E: --	M: --	Transmission	P1
CALC.TRIP.GEAR.{1..6}.DISTANCE_PCT.{ABTPF}	Percent distance travelled in each gear for trip A, B, T, P, and F	E: %	M: %	Transmission	P3
CALC.TRIP.GEAR.{1..6}.TIME_PCT.{ABTPF}	Percent time travelled in each gear for trip A, B, T, P, and F	E: %	M: %	Transmission	P3
CALC.TRIP.GEAR.N.DISTANCE_PCT.{ABTPF}	Percent distance travelled in no gear for trip A, B, T, P, and F	E: %	M: %	Transmission	P3
CALC.TRIP.GEAR.N.TIME_PCT.{ABTPF}	Percent time travelled in no gear for trip A, B, T, P, and F	E: %	M: %	Transmission	P3
CALC.TRIP.GEAR.WG.DISTANCE_PCT.{ABTPF}	Percent distance travelled in wrong gear for trip A, B, T, P, and F	E: %	M: %	Transmission	P3
CALC.TRIP.GEAR.WG.TIME_PCT.{ABTPF}	Percent time travelled in wrong gear for trip A, B, T, P, and F	E: %	M: %	Transmission	P3

**CALC.ACCELERATION**

Current acceleration based on vehicle speed

**E:** ft/s<sup>2</sup>**M:** m/s<sup>2</sup>

Performance

P1

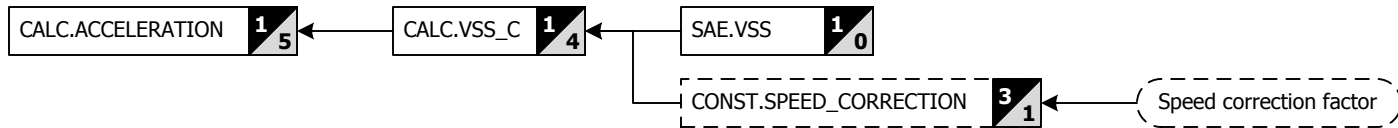

Acceleration, A is  $A = \Delta d / \Delta t$ , where  $\Delta d = (v_0 + v_1) / 2 * \Delta t$ ,  $\Delta t = t_1 - t_0$ ,  $v$  is velocity, and  $t$  is time.

[Contents](#)[Index](#)[Categories](#)

**CALC.ACCELERATION\_G**

Current acceleration expressed as a unit of gravity

**E:** g**M:** g

Performance

P1

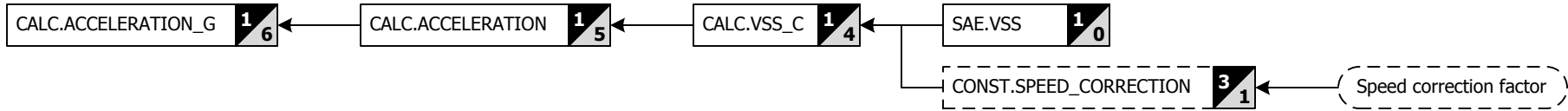
[Contents](#)[Index](#)[Categories](#)

**CALC.AFR\_ACTUAL**

Air/fuel ratio calculated from actual lambda

**E:** --**M:** --

Fuel

P1

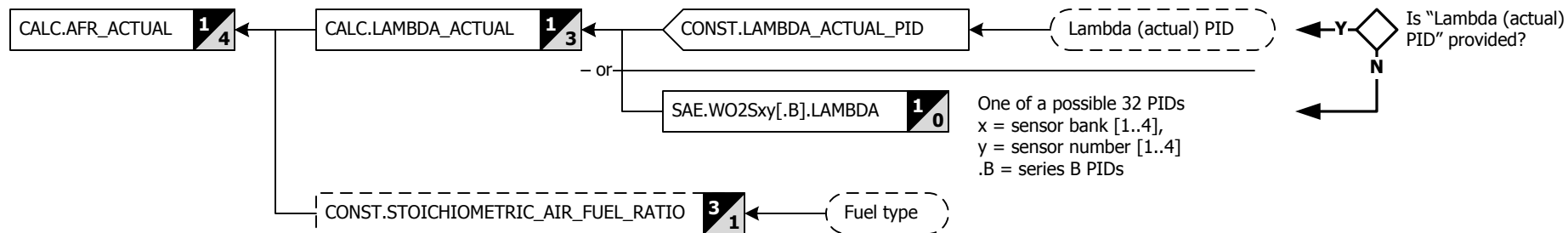

**Note:** This value will not be accurate for Diesel vehicles.

Given that  $\text{Lambda } (\lambda) = \text{AFR} / \text{AFR}_{\text{stoich}}$  we can solve for AFR (air fuel ratio) such as  $\text{AFR} = \lambda * \text{AFR}_{\text{stoich}}$ .

[Contents](#)[Index](#)[Categories](#)

**CALC.AFR\_CMDANDED**

Air/fuel ratio from commanded lambda

**E:** --**M:** --

Fuel

P1

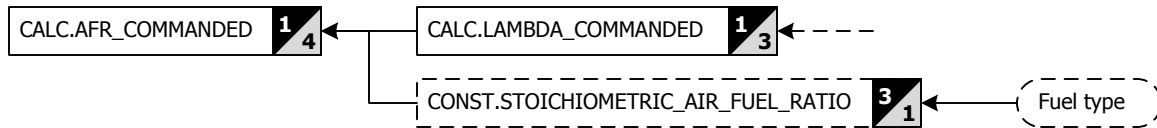

Given that Lambda ( $\lambda$ ) =  $AFR / AFR_{stoich}$  we can solve for AFR (air fuel ratio) such as  $AFR = \lambda * AFR_{stoich}$ .

[Contents](#)[Index](#)[Categories](#)



**CALC.AIR\_DENSITY**

Ambient air density

**E:** lb/ft<sup>3</sup>**M:** kg/m<sup>3</sup>

Environment

P2

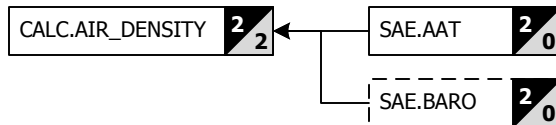

Ambient air density is calculated from the ambient air temperature, the barometric pressure if available (101.325 kPa is used when the PID is not available), and an average relative humidity (70%).

[Contents](#)[Index](#)[Categories](#)

## CALC.BOOST\_PRESSURE

Boost pressure estimation

E: psi M: kPa | bar | kg-f/cm<sup>2</sup> **1** Airflow

P1

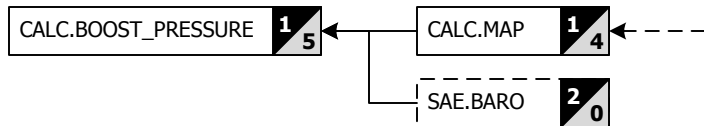

**1** Output unit is controlled by the 'Boost pressure' unit setting

Boost pressure ( $p_{\text{boost}}$ ) = MAP -  $p_{\text{baro}}$ , where MAP is the manifold absolute pressure. Negative values represent vacuum while positive values are boosted pressures usually generated by a turbocharger or supercharger.

[Contents](#)

[Index](#)

[Categories](#)

**CALC.DISTANCE**

Distance travelled since last fuel consumption dashboard reset

**E:** miles**M:** km

Distance

P1

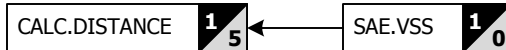

Total distance ( $d_T$ ) =  $d_T + \Delta d$ , where  $\Delta d = (v_0 + v_1)/2 * \Delta t$ ,  $\Delta t = t_1 - t_0$ ,  $d$  is distance, and  $t$  is time

[Contents](#)[Index](#)[Categories](#)

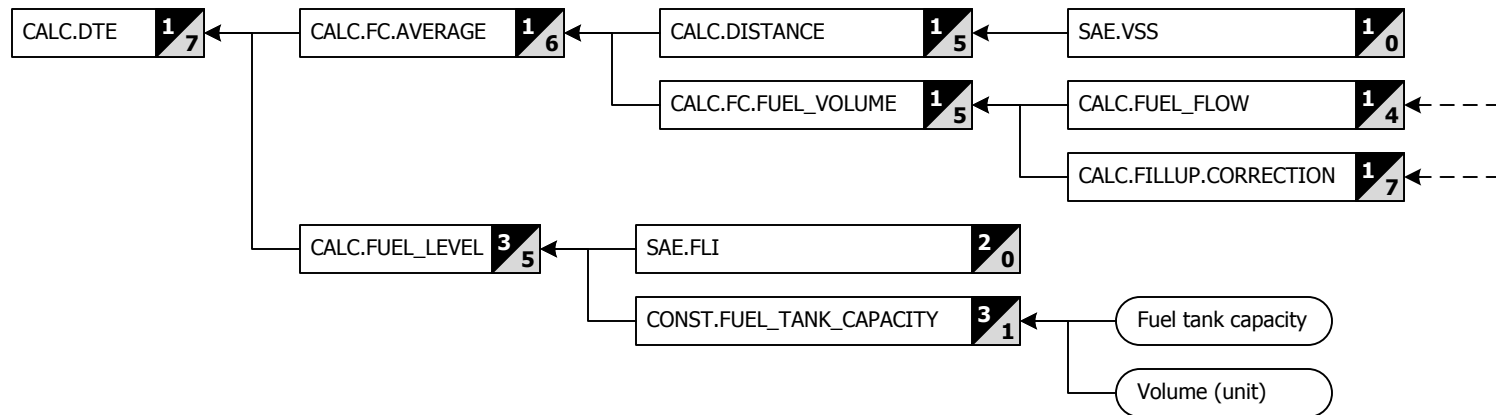

Distance to empty (DTE) = Average fuel economy [mpg] \* Fuel remaining in tank [gal]

4 Output unit is controlled by the 'Power' unit setting

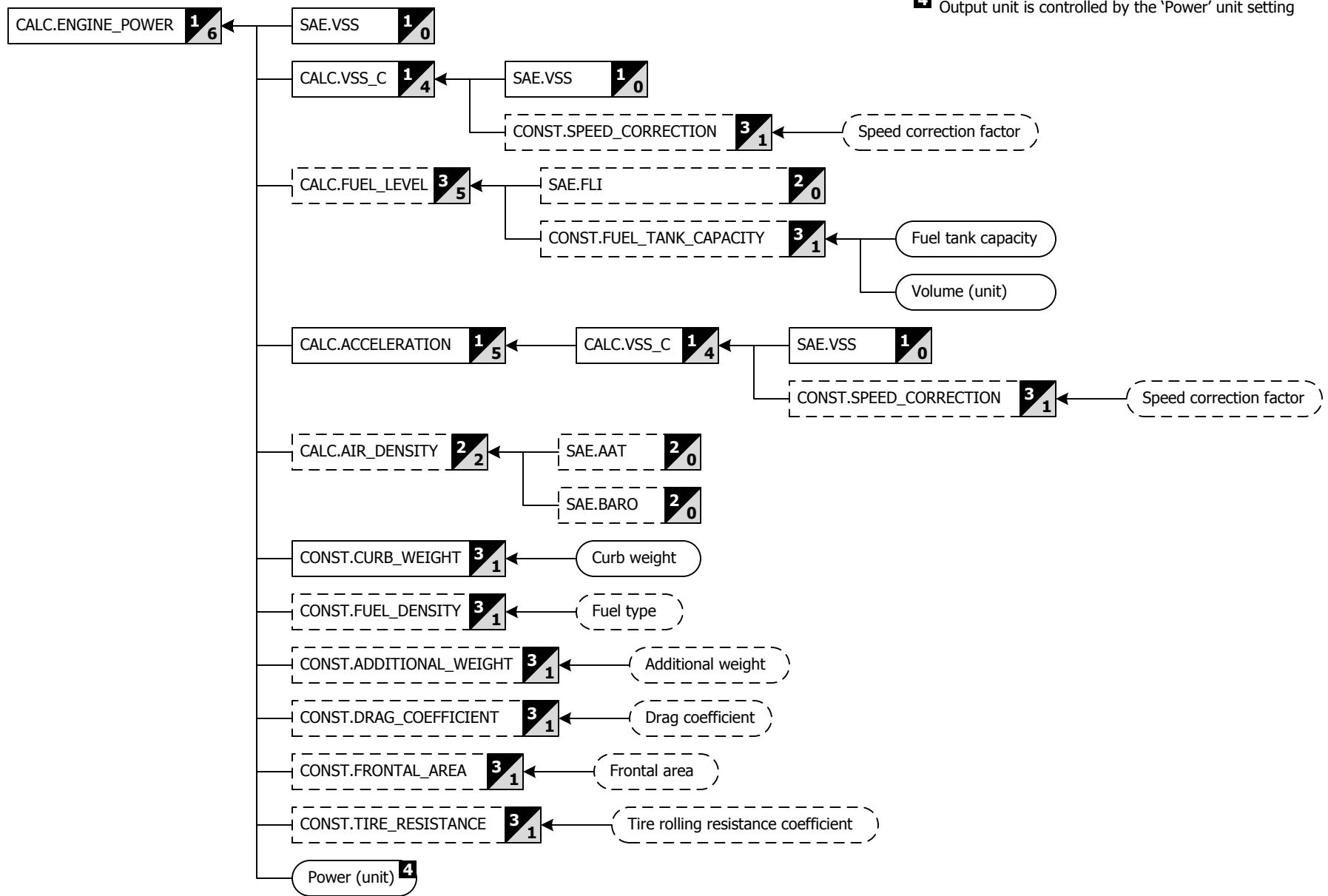

### Engine power

Engine power output at the wheels calculated from vehicle acceleration and vehicle mass. The calculation can also compensate for the power loss due to air resistance and tire rolling resistance when the corresponding vehicle settings are entered.

Curb weight is the only vehicle settings necessary for the calculation to produce a value. If SAE.FLI and the Fuel tank capacity setting are available, they will be used to calculate the mass of the fuel in the tank which is added to the vehicle's mass for a more accurate calculation. The Additional weight setting can be used to further adjust the vehicle's real mass and make the power calculation even more accurate.

**Tip:** When SAE.FLI is not available, the weight of the fuel in the tank can be added to the Additional weight setting.

Calculation method: Power,  $P = m \cdot a \cdot v$  where  $m$  is mass,  $a$  is acceleration, and  $v$  is velocity.

### Power loss due to air resistance

Providing the Drag coefficient and Frontal area vehicle settings will ensure that the power calculation compensates for the power loss due to air resistance. Air resistance also depends on air density and when CALC.AIR\_DENSITY is not available due to unavailable base PIDs, a value of 1.2242 [kg/m<sup>3</sup>] is used.

Combining the standard equation for power,  $P = F \cdot v$  and the equation for drag force,  $F_d = \frac{1}{2} \cdot \rho \cdot u^2 \cdot C_d \cdot A$ , gives Power loss due drag,  $P_d = \frac{1}{2} \cdot \rho \cdot u^3 \cdot C_d \cdot A$  where  $\rho$  is the air density,  $u$  is the vehicle velocity,  $C_d$  is the drag coefficient, and  $A$  is the frontal area.

### Power loss due to tire rolling resistance

Providing the Tire rolling resistance coefficient vehicle setting will ensure that the power calculation compensates for the power loss due to tire rolling resistance.

The force of rolling resistance is  $F_{rr} = C_{rr} \cdot N_f$  where  $N_f$  is the normal force =  $m \cdot (g + a)$  where  $m$  is the mass of the vehicle,  $g$  is the gravitational constant, and  $a$  is the acceleration up or down which is assumed to be zero. The power loss due to tire rolling resistance,  $P_{rr} = C_{rr} \cdot m \cdot g \cdot v$  where  $C_{rr}$  is the tire rolling resistance coefficient,  $m$  is the total mass of the vehicle,  $g$  is the gravitational constant, and  $v$  is the vehicle's velocity.

Engine power,  $P_E = P + P_d + P_{rr}$  from total power  $P = P_E - P_d - P_{rr}$

2 Output unit is controlled by the Torque' unit setting

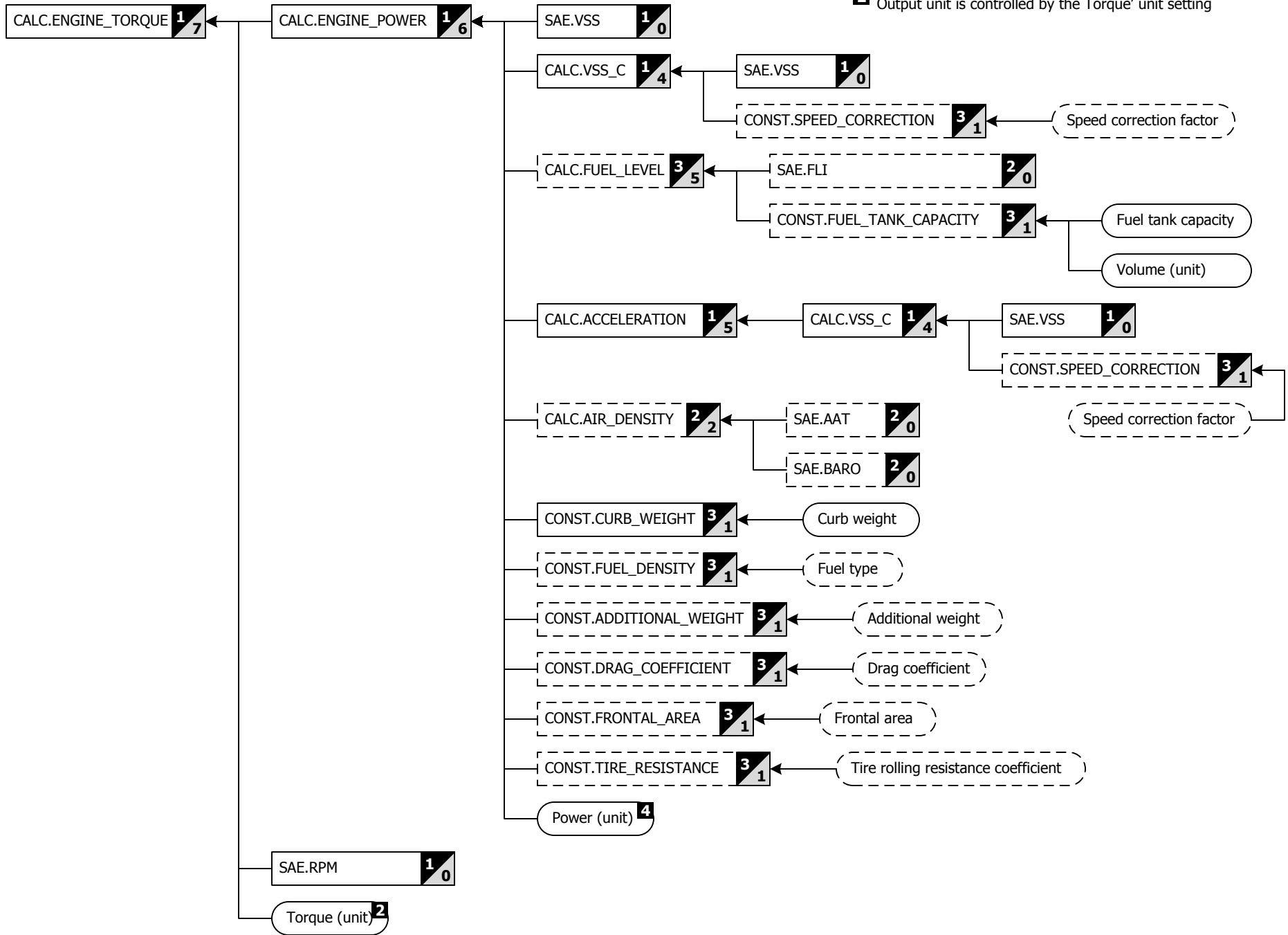

From power  $P = \tau \cdot \omega$  where  $\tau$  is Torque and  $\omega$  is angular velocity =  $2\pi \cdot$  rotational speed,  $P = \tau \cdot 2\pi \cdot$  rotational speed. Therefore, Torque  $\tau = P / (2\pi \cdot \text{rotational speed})$ .  $\pi$  is Pi.

<sup>3</sup> Output unit is controlled by the 'Volume' unit setting

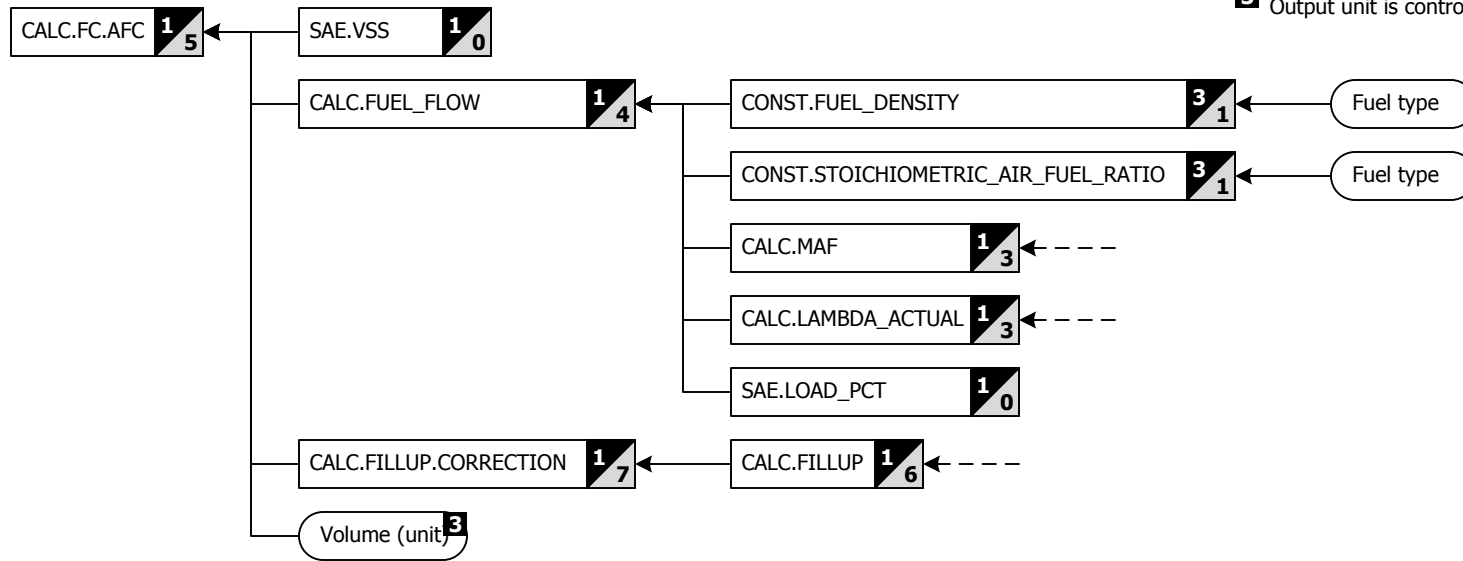

For each time period, Average Fuel Consumption,  $AFC = \text{fuel}_T / d_T$   
 Where  $\text{fuel}_T$  is the total fuel consumed during the time period and  $d_T$  is the total distance travelled during the time period.

Note: English units are expressed as average fuel economy.

For each time period, Average Fuel Consumption,  $AFC = \text{fuel}_T / d_T$   
 Where  $\text{fuel}_T$  is the total fuel consumed during the time period and  $d_T$  is the total distance travelled during the time period.

Note: English units are expressed as average fuel economy.

$$\text{fuel}_T = \text{fuel}_T + \Delta \text{fuel}, \Delta \text{fuel} = (\text{flow}_0 + \text{flow}_1) / 2 \cdot \Delta t, \Delta t = (t_1 - t_0)$$

$$d_T = d_T + \Delta d, \Delta d = (v_0 + v_1) / 2 \cdot \Delta t, \Delta t = (t_1 - t_0)$$

$$d_T = d_T + \Delta d, \Delta d = (v_0 + v_1) / 2 \cdot \Delta t, \Delta t = (t_1 - t_0)$$

<sup>3</sup> Output unit is controlled by the 'Volume' unit setting

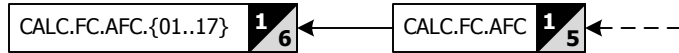

### Average fuel consumption series

Average fuel economy / consumption values for various time periods.

CALC.FC.AFC calculates average fuel economy / consumption values for 17 time periods and outputs a series of values. This value series is then used by the CALC.FC.AFC.xx PIDs to output individual values for each of the 17 time periods.

Short term fuel economy / consumption values

CALC.FC.AFC.01 - 0 to 1 minute interval  
CALC.FC.AFC.02 - 1 to 2 minute interval  
CALC.FC.AFC.03 - 2 to 3 minute interval  
CALC.FC.AFC.04 - 3 to 4 minute interval  
CALC.FC.AFC.05 - 4 to 5 minute interval

Medium term fuel economy / consumption values

CALC.FC.AFC.06 - 0 to 5 minute interval  
CALC.FC.AFC.07 - 5 to 10 minute interval  
CALC.FC.AFC.08 - 10 to 15 minute interval  
CALC.FC.AFC.09 - 15 to 20 minute interval  
CALC.FC.AFC.10 - 20 to 25 minute interval  
CALC.FC.AFC.11 - 25 to 30 minute interval

Long term fuel economy / consumption values

CALC.FC.AFC.12 - 0 to 30 minute interval  
CALC.FC.AFC.13 - 30 to 60 minute interval  
CALC.FC.AFC.14 - 60 to 90 minute interval  
CALC.FC.AFC.15 - 90 to 120 minute interval  
CALC.FC.AFC.16 - 120 to 150 minute interval  
CALC.FC.AFC.17 - 150 to 180 minute interval

[Contents](#)[Index](#)[Categories](#)



**CALC.FC.AVERAGE**

Average fuel economy since last fuel dashboard reset

E: mpg(US) | mpg(UK)

**3**

M: l/100km

Fuel

P1

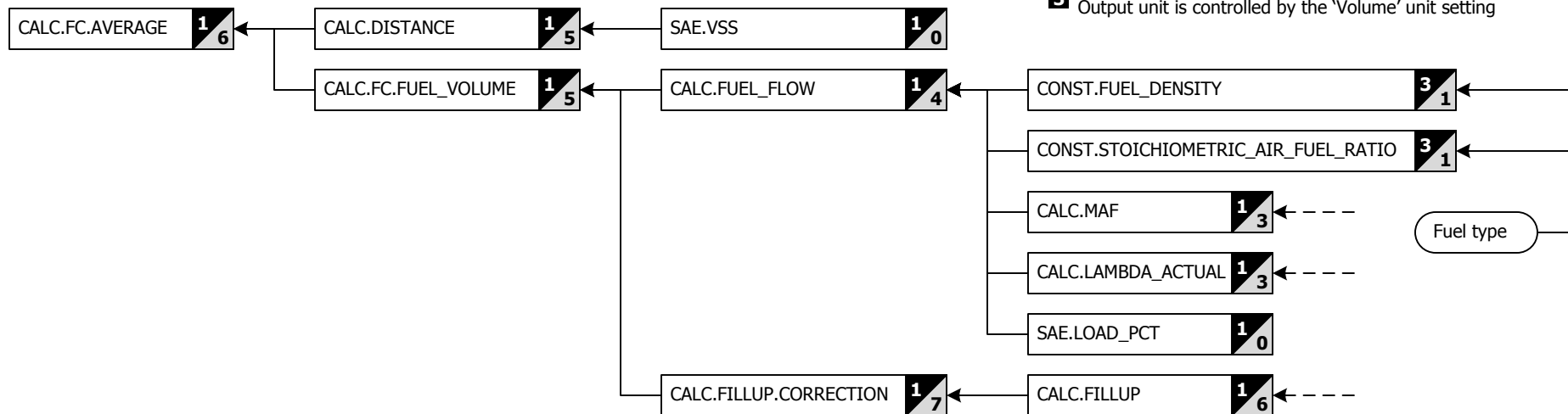
**3** Output unit is controlled by the 'Volume' unit settingAverage Fuel Consumption,  $FC.AVERAGE = fuel_T / d_T$ Where  $fuel_T$  is the total fuel consumed during the time period and  $d_T$  is the total distance travelled during the time period.

Note: English units are expressed as average fuel economy.

[Contents](#)[Index](#)[Categories](#)

**CALC.FC.FUEL\_VOLUME**

Volume of fuel consumed since last fuel dashboard reset

**E:** gal(US | gal(UK) **3****M:** l

Fuel

P1

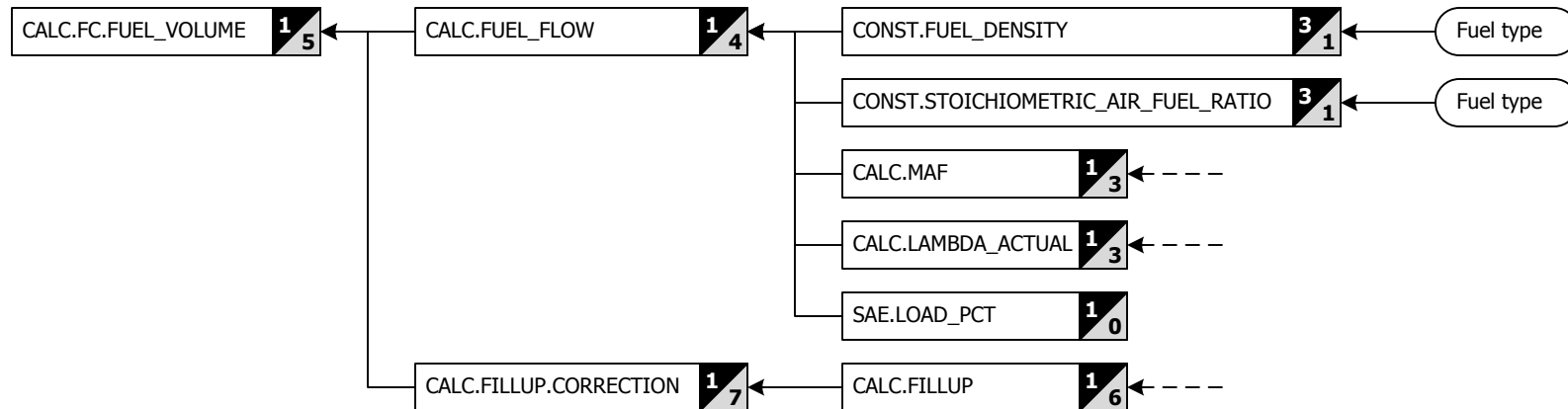
**3** Output unit is controlled by the 'Volume' unit setting

Total fuel consumed,  $\text{fuel}_T = \text{fuel}_T + \Delta\text{fuel}$  where  $\Delta\text{fuel} = (\text{flow}_0 + \text{flow}_1)/2 \cdot \Delta t$  and  $\Delta t = (t_1 - t_0)$

[Contents](#)[Index](#)[Categories](#)

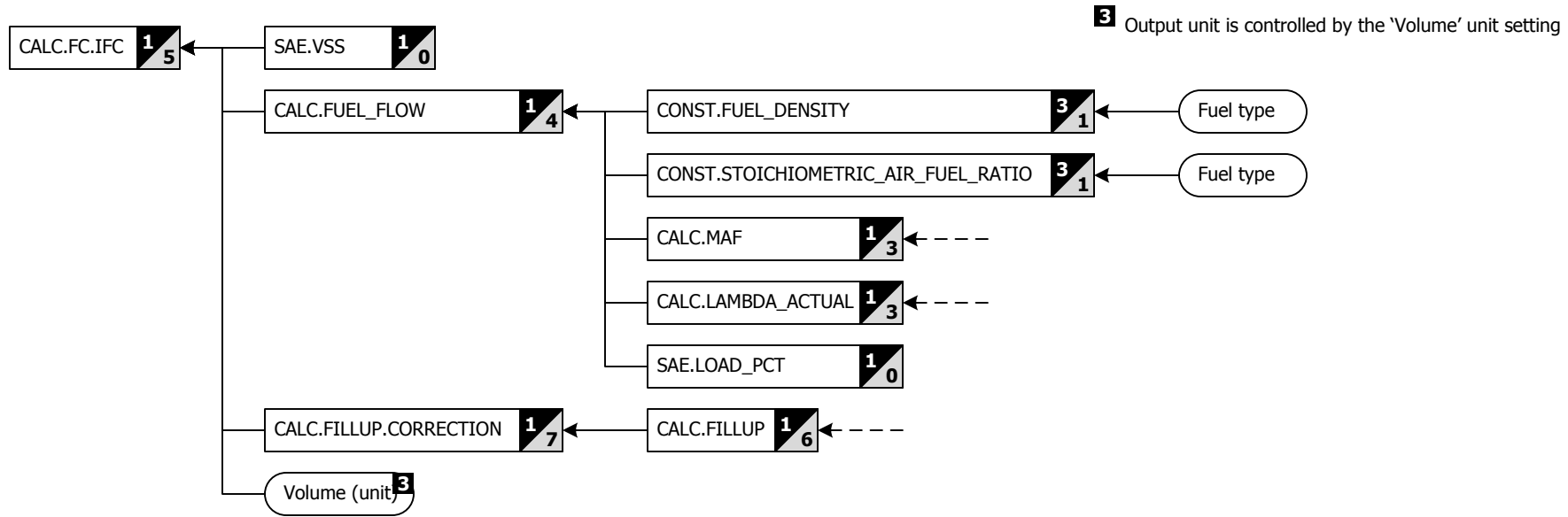

Instantaneous fuel economy / consumption is calculated from the current fuel flow and the current vehicle speed. It can only be calculated when the vehicle is moving and the engine is operating.

Instantaneous Fuel Consumption, IFC = fuel\_flow / vehicle\_speed

**CALC.FC.IFC\_AVG**

Average instantaneous fuel economy/consumption

**E:** mpg(US) | mpg(UK)**3****M:** l/100km

Fuel

P1

**3**

Output unit is controlled by the 'Volume' unit setting

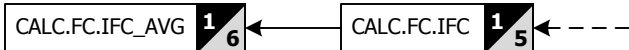

Note: This value is not equivalent to average fuel economy/consumption.

[Contents](#)[Index](#)[Categories](#)

**CALC.FILLUP**

Manages the values displayed on Fillup dashboard

**E:** --**M:** --

System

P1

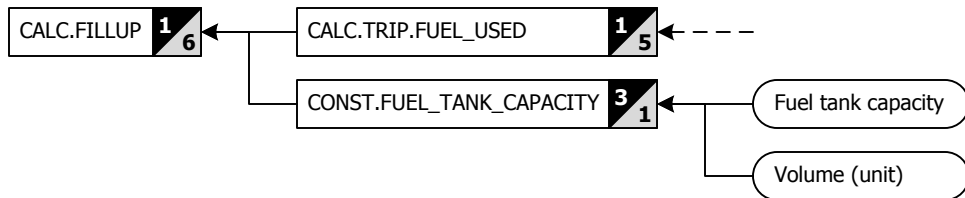

This PID manages the fuel consumption calibration process which is executed after each fuel tank fill up. It outputs the fuel consumption correction value, fuel prices, and the amount of fuel added to the fuel tank.

[Contents](#)[Index](#)[Categories](#)

## CALC.FILLUP.CORRECTION

Fuel consumption correction factor obtained form Fillup dashboard

**E:** %

**M:** coefficient

Fuel

P1

CALC.FILLUP.CORRECTION

1/7

CALC.FILLUP

1/6

[Contents](#)

[Index](#)

[Categories](#)

**CALC.FILLUP.FUEL\_PRICE**

Fuel price entered at last fill up

**E:** cur (input)

**M:** cur (blended)

Fuel

P1

CALC.FILLUP.FUEL\_PRICE **1/7**

CALC.FILLUP **1/6**

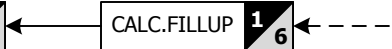

**Contents**

**Index**

**Categories**

**CALC.FILLUP.FUEL\_USED**

Volume of fuel used since last fillup

**E:** gal(US) | gal(UK) **3**

**M:** |

Fuel

P1

**3** Output unit is controlled by the 'Volume' unit setting

CALC.FILLUP.FUEL\_USED

1/7

CALC.FILLUP

1/6

[Contents](#)

[Index](#)

[Categories](#)



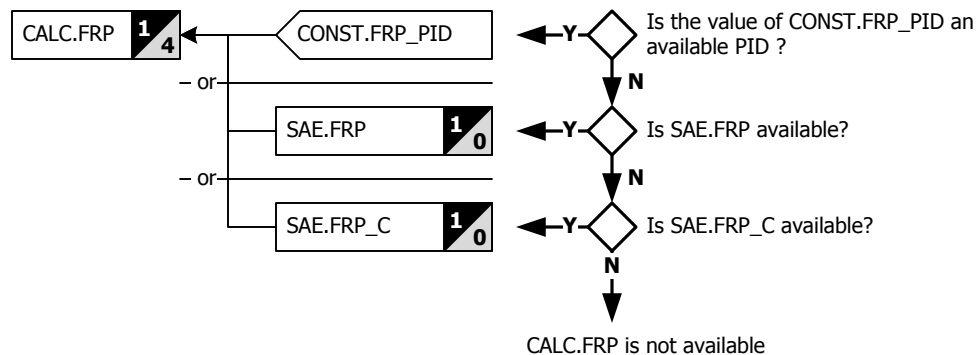

There are two main FRP PIDs, one for normal fuel pressure and one for high fuel pressure used in direct injection applications. This PID outputs the value of the PID that is available for the vehicle.

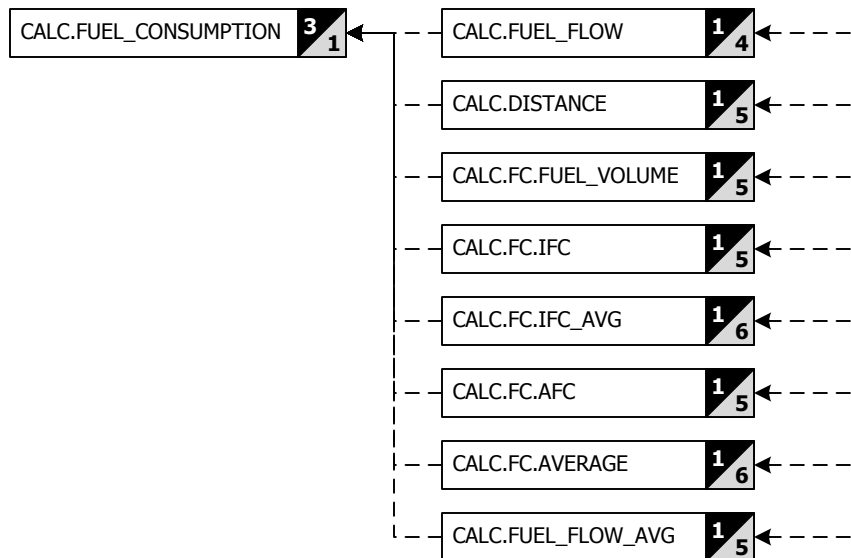

Logging or monitoring this PID is equivalent to logging or monitoring all the listed PIDs.

**CALC.FUEL\_FLOW**

Fuel flow rate derived from mass air flow

**E:** gal(US)/h | gal(UK)/h <sup>3</sup> **M:** l/h Fuel

P1

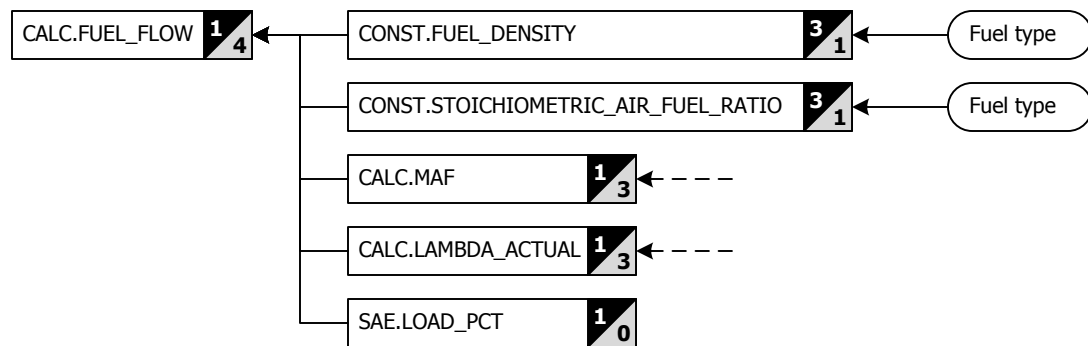

<sup>3</sup> Output unit is controlled by the 'Volume' unit setting

$\text{fuel\_flow} = \text{mass\_air\_flow} / (\text{AFR}_{\text{actual}} * \text{fuel\_density})$  where  $\text{AFR}_{\text{actual}} = \text{lambda} * \text{AFR}_{\text{stoich}}$   
SAE.LOAD\_PCT is only used when 'Fuel type' = "Diesel" to pre-adjust the mass\_air\_flow value.

[Contents](#)[Index](#)[Categories](#)

## CALC.FUEL\_FLOW\_AVG

Average fuel flow rate derived from mass air flow

E: gal(US)/h | gal(UK)/h <sup>3</sup> M: l/h Fuel

P1

<sup>3</sup> Output unit is controlled by the 'Volume' unit setting

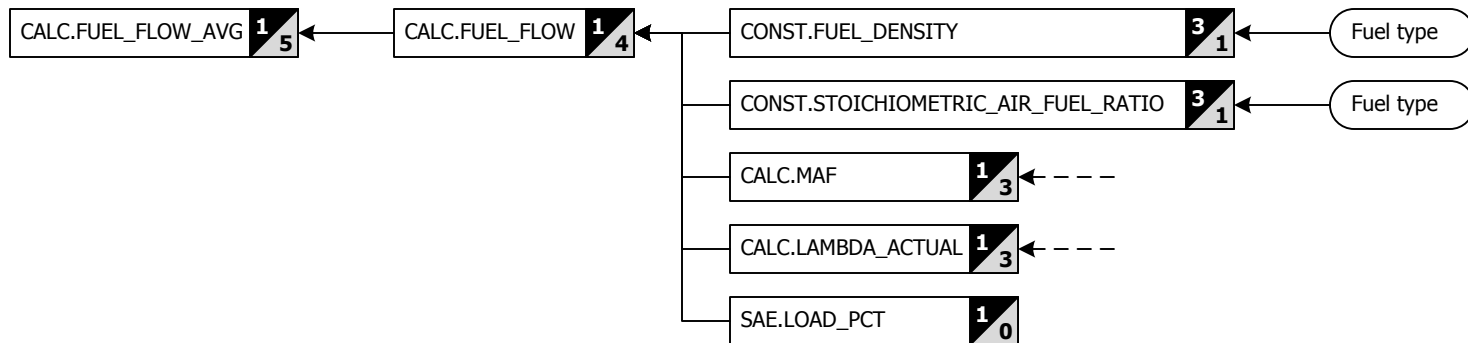

This PID is provided to replace the built-in Average value of CALC.FUEL\_FLOW which erroneously includes zero values in the average.

[Contents](#)

[Index](#)

[Categories](#)

**CALC.FUEL\_LEVEL**

Volume of fuel remaining in fuel tank

**E:** gal(US | gal(UK) **3** **M:** l

Fuel

P1

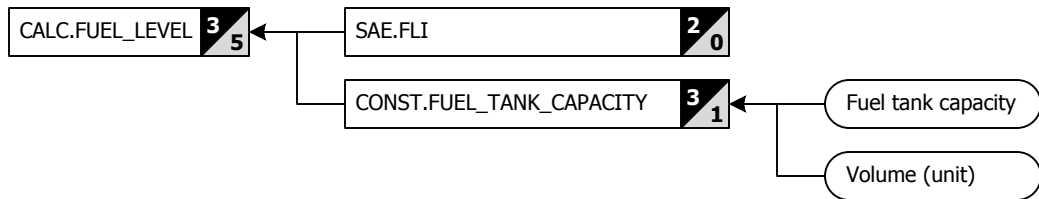
**3** Output unit is controlled by the 'Volume' unit setting

$$\text{fuel\_level} = \text{fuel\_tank\_capacity} * \text{FLI} / 100$$

[Contents](#)[Index](#)[Categories](#)

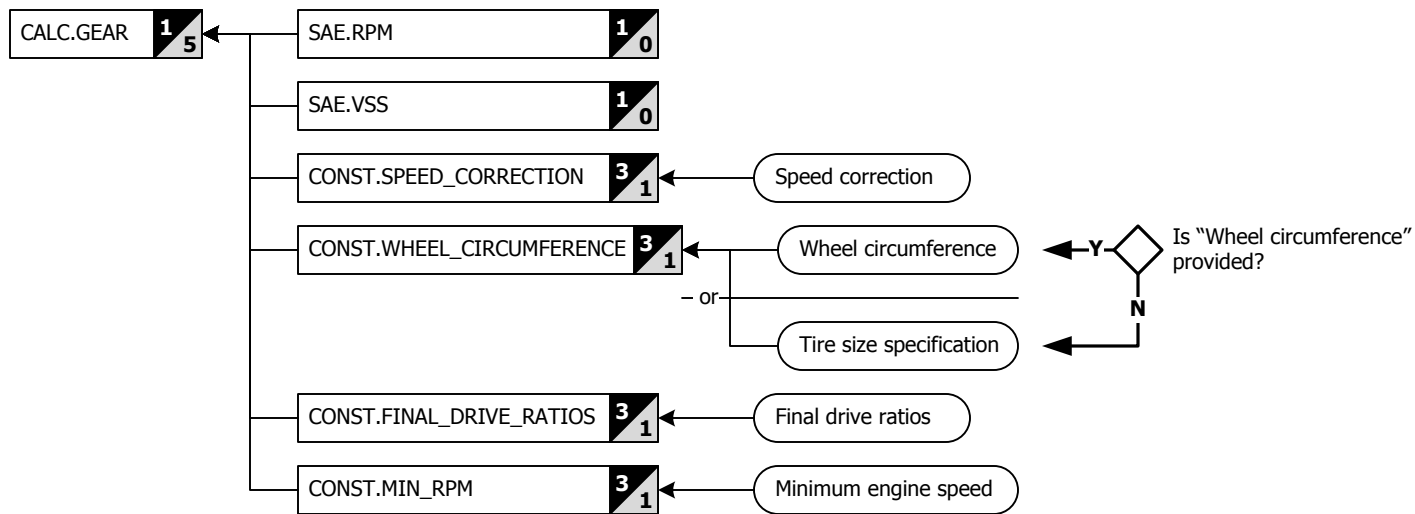

The current gear is determined by calculating an observed final drive ratio and matching it up to one of the final drive ratios provided by the vehicle setting. When no match is found the gear is undetermined and could mean that the vehicle is in neutral or a shift is in progress.

**CALC.GEAR.CURRENT**

Currently engaged gear

**E:** --

**M:** --

Transmission

P1

CALC.GEAR.CURRENT

1  
6

CALC.GEAR

1  
5

[Contents](#)

[Index](#)

[Categories](#)

**CALC.GEAR.NUM\_GEAR**

Number of gears

**E:** --

**M:** --

Transmission

P3

CALC.GEAR.NUM\_GEAR

1  
6

CALC.GEAR

1  
5

[Contents](#)

[Index](#)

[Categories](#)



**CALC.GEAR.SHIFT\_INDICATOR**

Indicates that a shift is suggested and in which direction

**E:** --**M:** --

Transmission

P1

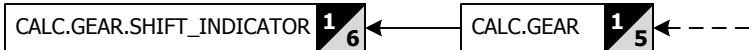

Negative values indicate that a down shift is suggested while positive values indicate an up shift is suggested.

[Contents](#)[Index](#)[Categories](#)

**CALC.GEAR.SUGGESTED**

Suggested gear to best match the current speed

**E:** --

**M:** --

Transmission

P1

CALC.GEAR.SUGGESTED

**1**/**6**

CALC.GEAR

**1**/**5**

[Contents](#)

[Index](#)

[Categories](#)

## CALC.IS\_NEW\_DAY

Returns true when a new day starts

**E:** --

**M:** --

Time

P3

CALC.IS\_NEW\_DAY

3  
2

Start of day



Normally returns false except for a brief moment at the start of a new day when the value returned is true.

[Contents](#)

[Index](#)

[Categories](#)

**CALC.LAMBDA\_ACTUAL**

Actual lambda read from a wideband oxygen sensor

**E:** --**M:** --

Fuel

P1

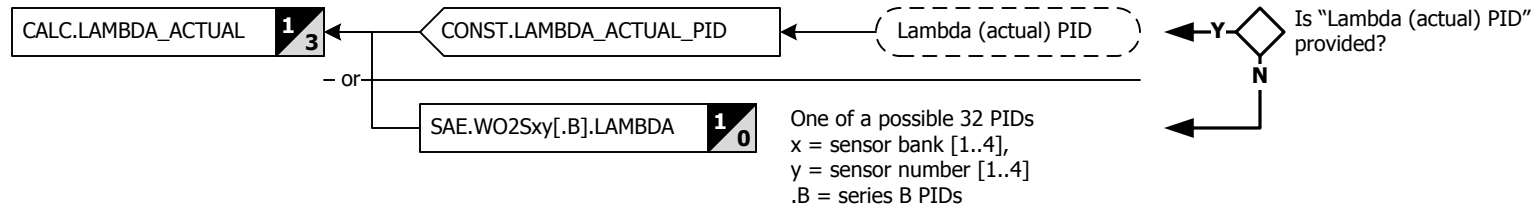

No calculation is done here, the value of the most appropriate Lambda PID is passed through.

[Contents](#)[Index](#)[Categories](#)

**CALC.LAMBDA\_COMMANDED**

Commanded lambda as directed by ECU

**E:** --**M:** --

System

P1

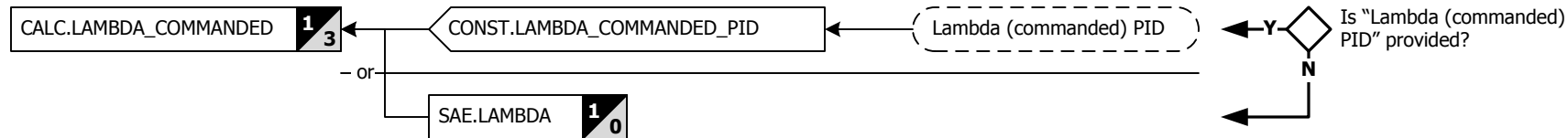

No calculation is done here, the value of the most appropriate commanded Lambda PID is passed through.

[Contents](#)[Index](#)[Categories](#)

**CALC.MAF**

Mass air flow – uses best possible calculation method

**E:** lb/min**M:** g/s

Airflow

P1

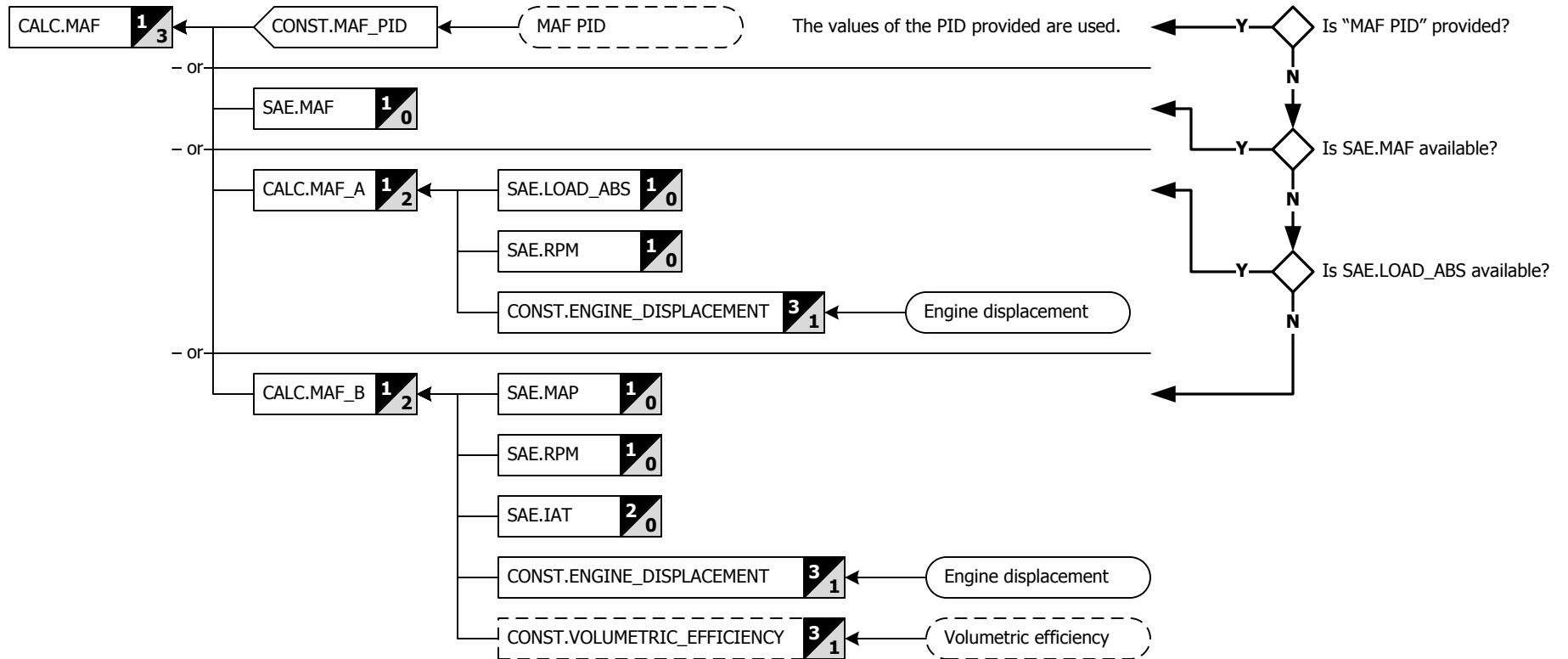

CALC.MAF passes along the values from the best possible MAF PID.

[Contents](#)[Index](#)[Categories](#)

**CALC.MAF\_A**

Mass air flow – Method A (LOAD\_ABS+RPM)

**E:** lb/min**M:** g/s

Airflow

P1

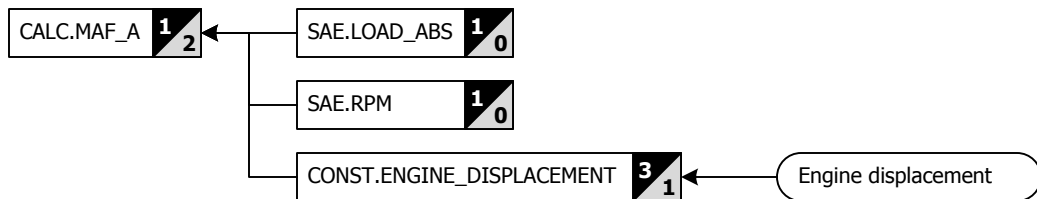

The OBD specification states:

$$\text{LOAD\_ABS} = [\text{air mass (g / intake stroke)}] / [1.184 \text{ (g / liter)} * \text{cylinder displacement (liters / intake stroke)}]$$

Therefore, MAF can be calculate as:

$$\text{mass\_air\_flow [g/s]} = 1.184 \text{ [g/l]} * \text{displacement [l/intake stroke]} * \text{load\_abs} / 100 * \text{engine\_speed [r/min]} / 2 \text{ [r/intake stroke]} / 60 \text{ [sec/min]}$$
[Contents](#)[Index](#)[Categories](#)

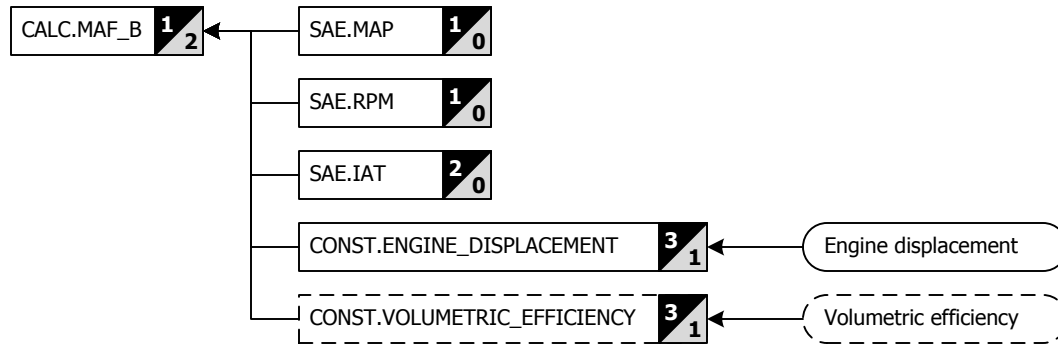

This method for calculating MAF (mass air flow) is based on the Ideal Gas Law.

$MAF [g/s] = (MAP/IAT) * (M/R) * (RPM/60) * (ED/2) * VE$ , where

MAP [kPa] is the manifold absolute pressure

IAT [K] is the intake air temperature

M [g/mol] is the molecular mass of air

R [J/(K\* $mol$ )] is gas constant for air

RPM [r/min] is the engine speed

ED [l] is the engine displacement

VE is the volumetric efficiency

When the 'Volumetric efficiency' vehicle setting is not provided a value of 75% is used by default.





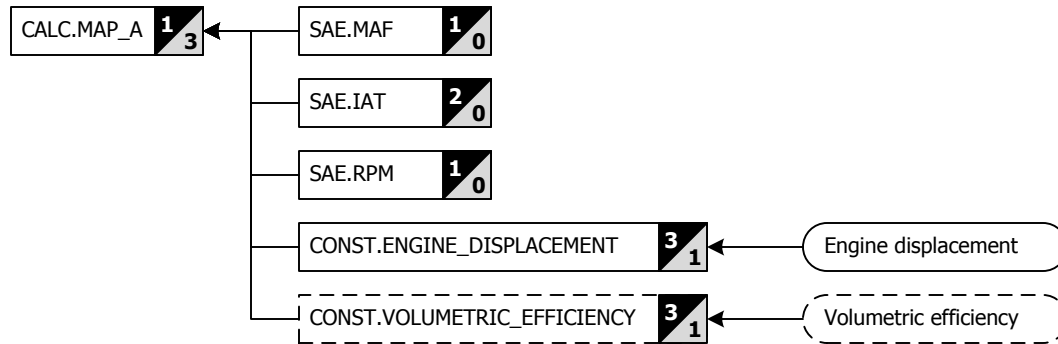

This method for calculating MAP (manifold absolute pressure) is based on the Ideal Gas Law.

$MAP [kPa] = (MAF * IAT) / ( (M/R) * (RPM/60) * (ED/2) * VE )$ , where

MAF [g/s] is the mass air flow  
 IAT [K] is the intake air temperature  
 M [g/mol] is the molecular mass of air  
 R [J/(K\*mol)] is gas constant for air  
 RPM [r/min] is the engine speed  
 ED [l] is the engine displacement  
 VE is the volumetric efficiency

When the 'Volumetric efficiency' vehicle setting is not provided a value of 75% is used by default.

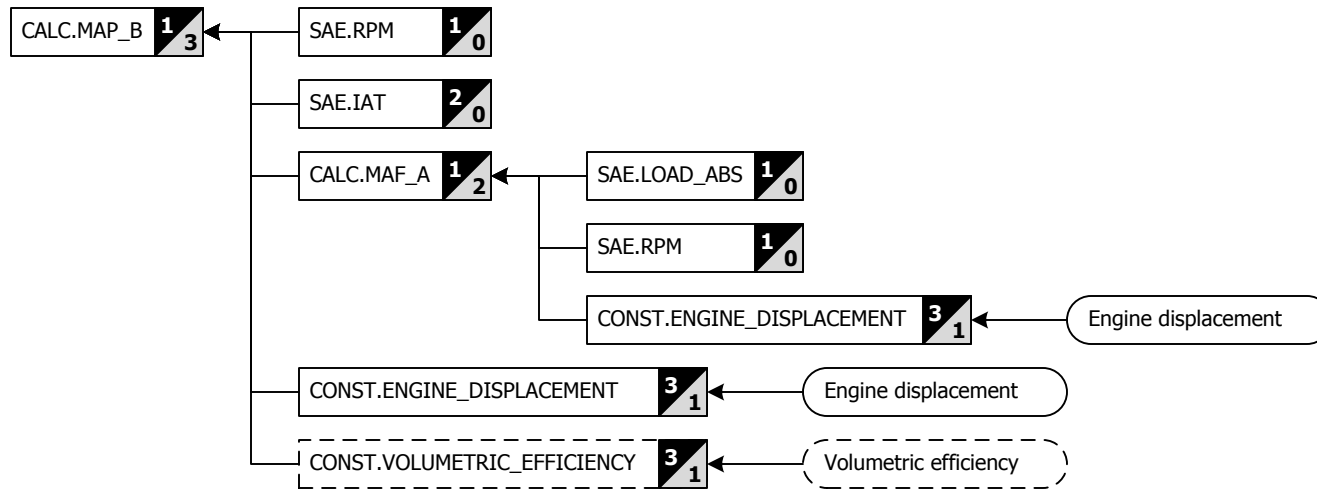

This method for calculating MAP (manifold absolute pressure) is based on the Ideal Gas Law.

$MAP [kPa] = (MAF * IAT) / ( (M/R) * (RPM/60) * (ED/2) * VE )$ , where

MAF [g/s] is the mass air flow  
 IAT [K] is the intake air temperature  
 M [g/mol] is the molecular mass of air  
 R [J/(K\*mol)] is gas constant for air  
 RPM [r/min] is the engine speed  
 ED [l] is the engine displacement  
 VE is the volumetric efficiency

When the 'Volumetric efficiency' vehicle setting is not provided a value of 75% is used by default.

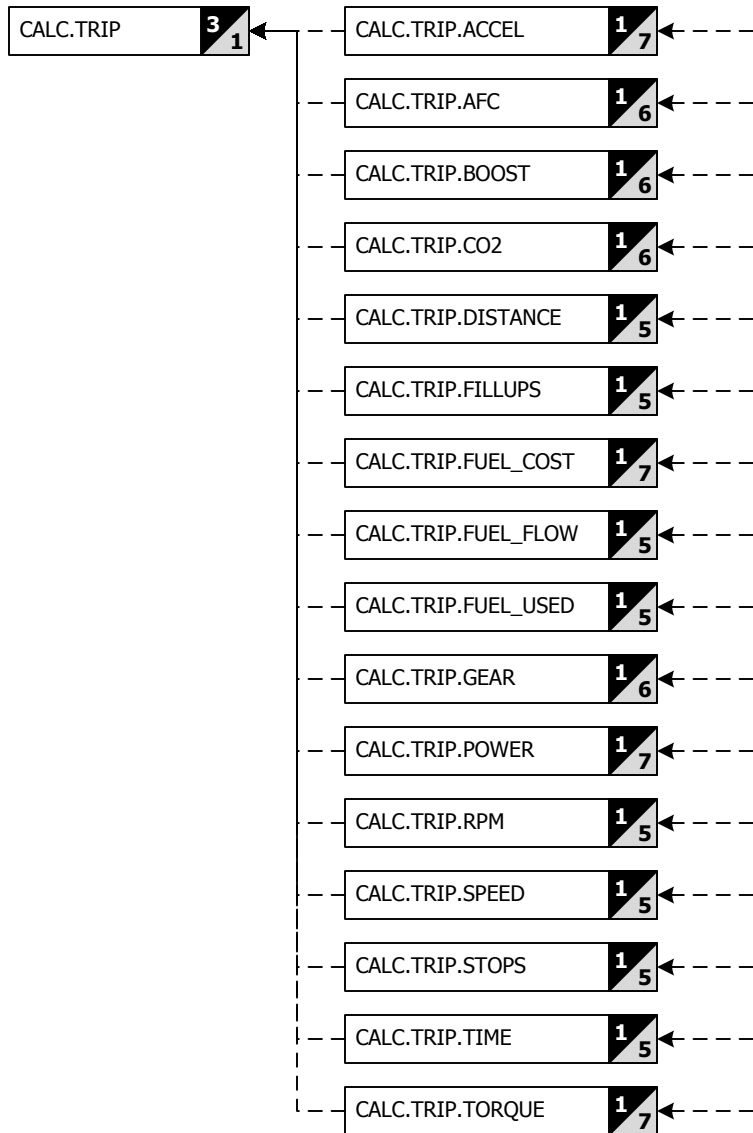

Logging or monitoring this PID is equivalent to logging or monitoring all the listed PIDs.

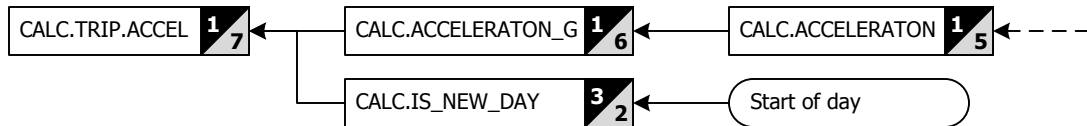

[Contents](#)

[Index](#)

[Categories](#)

**CALC.TRIP.ACCEL.BRAKING.MAX.{ABTPF}**

Maximum braking acceleration for trips A, B, T, P, and F

**E:** g

**M:** g

Performance

P3

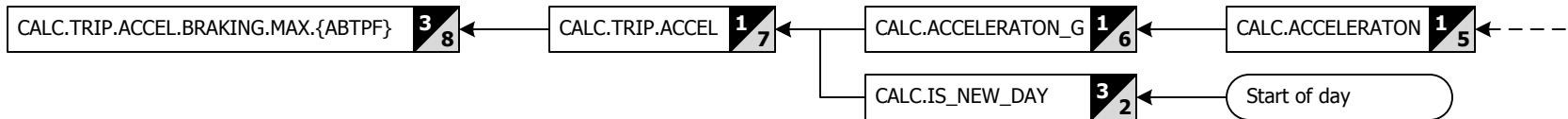

[Contents](#)

[Index](#)

[Categories](#)

**CALC.TRIP.ACCEL.FORWARD.MAX.{ABTPF}**

Maximum forward acceleration for trips A, B, T, P, and F

**E:** g**M:** g

Performance

P3

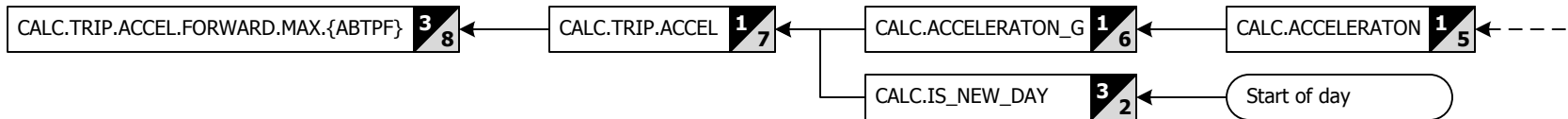
[Contents](#)[Index](#)[Categories](#)

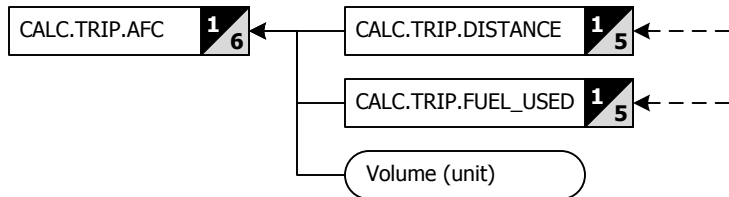

[Contents](#)

[Index](#)

[Categories](#)



**CALC.TRIP.AFC.{ABTPF}**

Average fuel consumption for trips A, B, T, P, and F

**E:** mpg(US) | mpg(UK) **3** **M:** l/100km

Fuel

P3

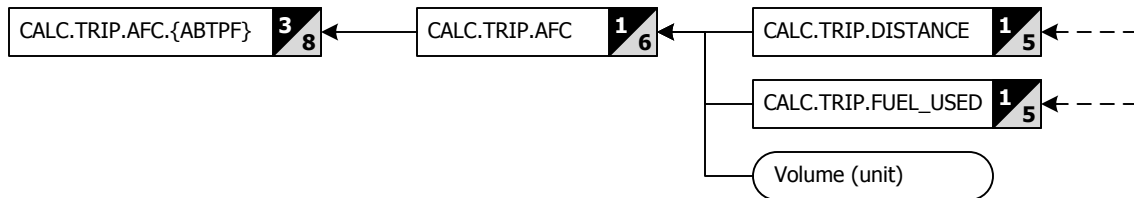

**3** Output unit is controlled by the 'Volume' unit setting

[Contents](#)

[Index](#)

[Categories](#)

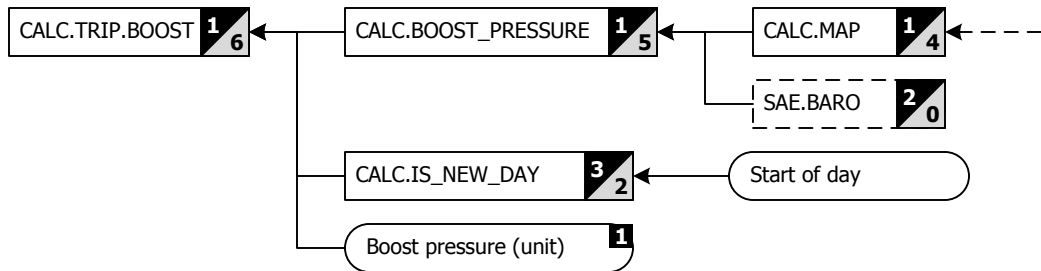

[Contents](#)

[Index](#)

[Categories](#)

**CALC.TRIP.BOOST.AVG.{ABTPF}**

Average boost pressure for trips A, B, T, P, and F

**E:** psi **M:** kPa | bar | kg-f/cm<sup>2</sup> **1** Airflow

P3

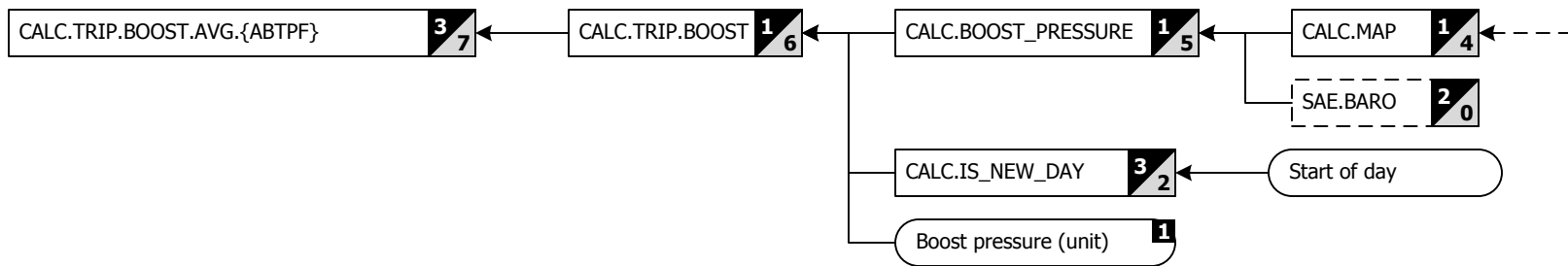
[Contents](#)[Index](#)[Categories](#)

**CALC.TRIP.BOOST.MAX\_BOOST.{ABTPF}**

Maximum boost pressure for trips A, B, T, P, and F

**E:** psi **M:** kPa | bar | kg-f/cm<sup>2</sup> **1** Airflow

P3

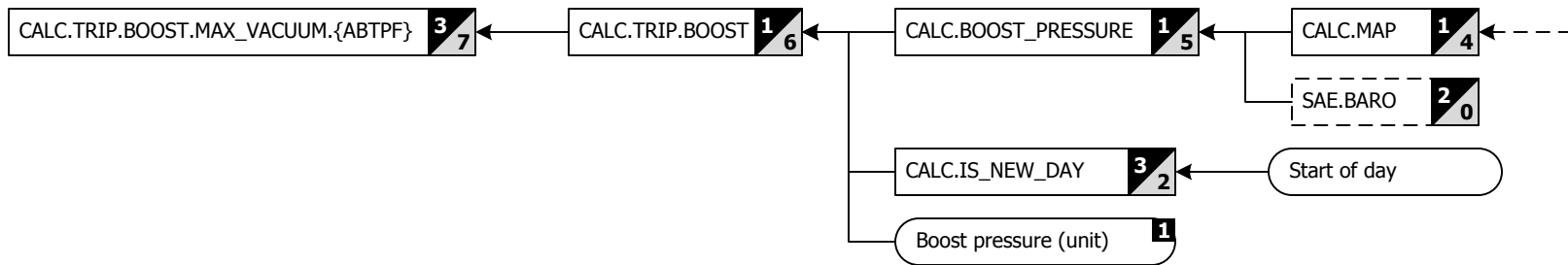
**1** Output unit is controlled by the 'Boost pressure' unit setting[Contents](#)[Index](#)[Categories](#)

**CALC.TRIP.CO2**

Carbon dioxide (CO2) emissions stats for the trip computer

**E:** --**M:** --

System

P1

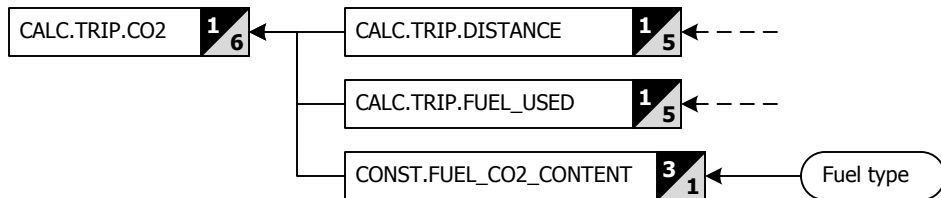
[Contents](#)[Index](#)[Categories](#)

**CALC.TRIP.CO2.RATE.{ABTPF}**

Average carbon dioxide emission rate for trip A, B, T, P, and F

**E:** oz/mi

**M:** g/km

Emissions

P3

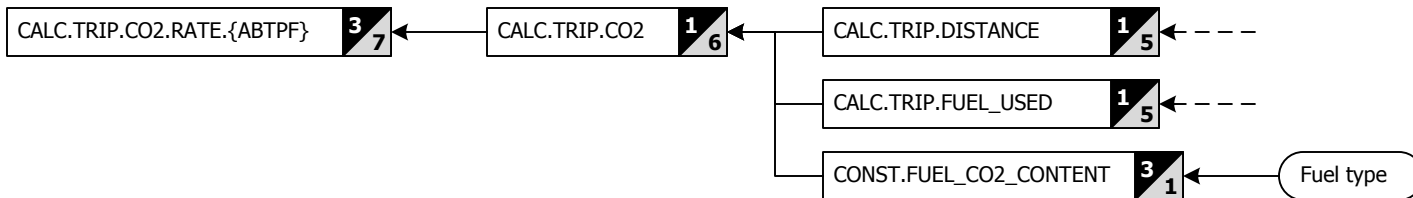

Contents

Index

Categories

**CALC.TRIP.CO2.TOTAL.{ABTPF}**

Total carbon dioxide emission for trip A, B, T, P, and F

**E:** lb

**M:** kg

Emissions

P3

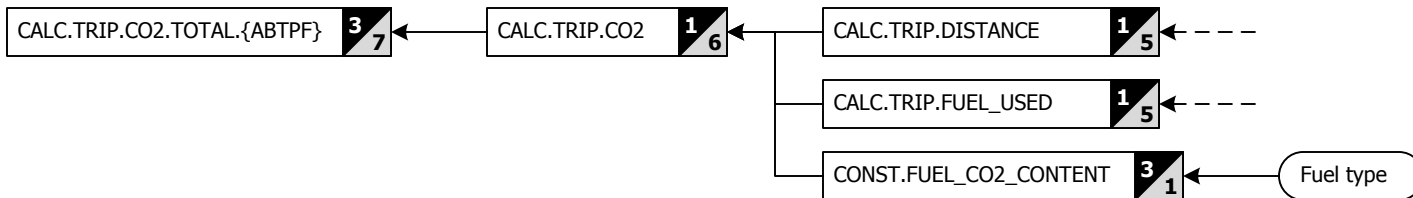

[Contents](#)

[Index](#)

[Categories](#)

**CALC.TRIP.DISTANCE**

Distance stats for trip computer

**E:** --**M:** --

System

P1

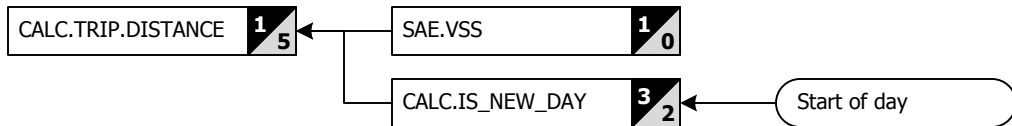
[Contents](#)[Index](#)[Categories](#)



**CALC.TRIP.DISTANCE.{ABTPF}**

Distance travelled for trip A, B, T, P, and F

**E:** miles

**M:** km

Distance

P3

CALC.TRIP.DISTANCE.{ABTPF} **3**/**6**

CALC.TRIP.DISTANCE **1**/**5**

SAE.VSS **1**/**0**

CALC.IS\_NEW\_DAY **3**/**2**

Start of day

[Contents](#)

[Index](#)

[Categories](#)

**CALC.TRIP.FILLUPS**

Fill up stats for trip computer

**E:** --**M:** --

System

P1

[Contents](#)[Index](#)[Categories](#)

# CALC.TRIP.FILLUPS.{ABTPF}

Number of fill ups for trip A, B, T, P, and F

E: --

M: --

Fuel

P3

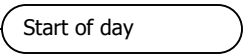
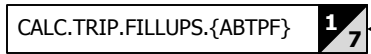

[Contents](#)

[Index](#)

[Categories](#)

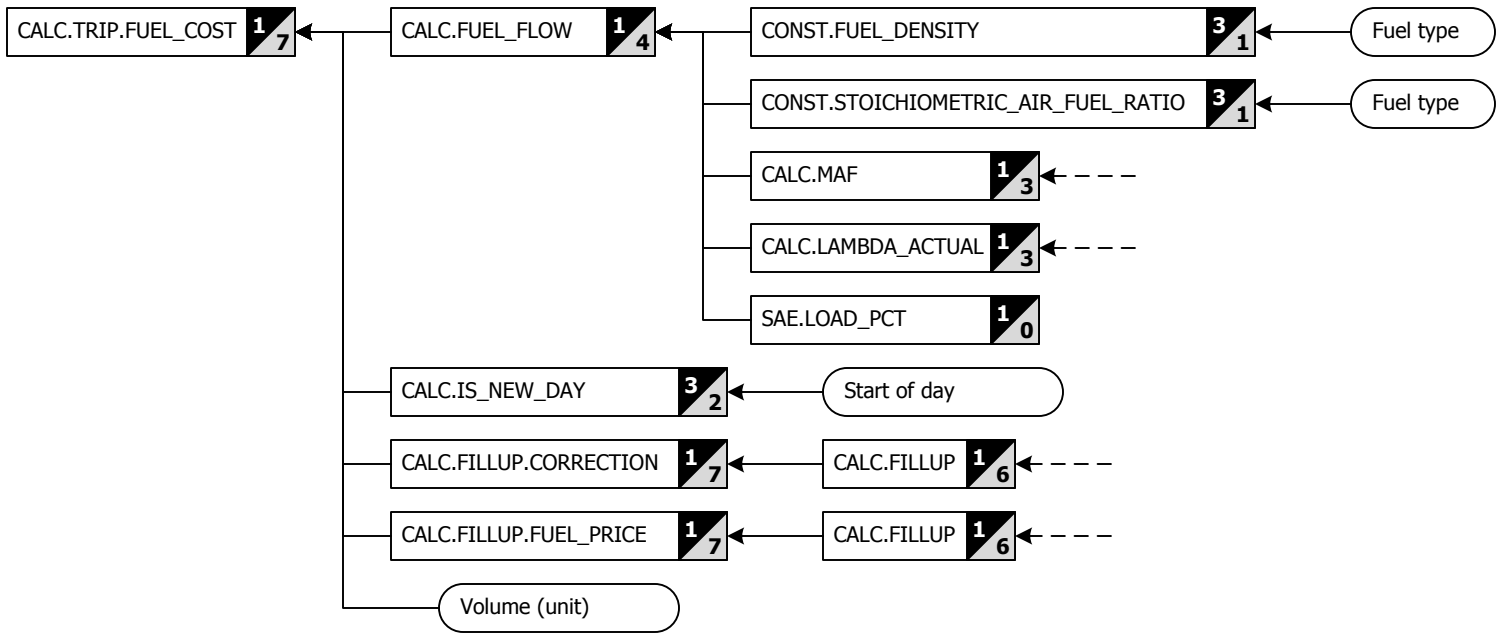

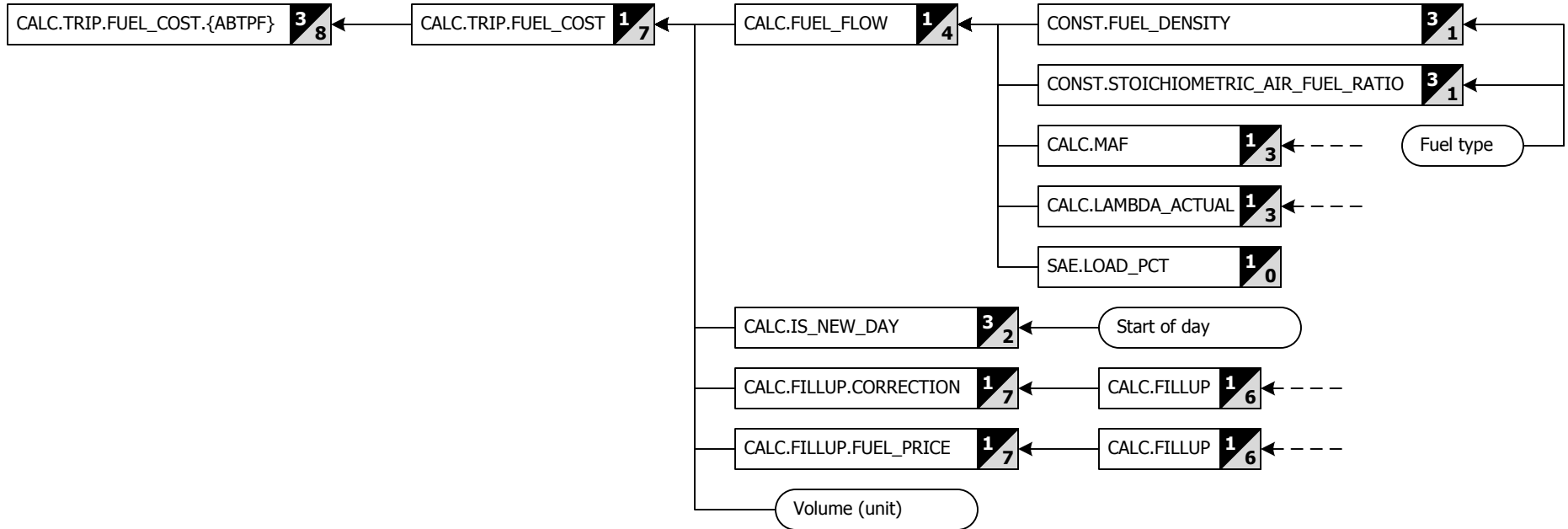

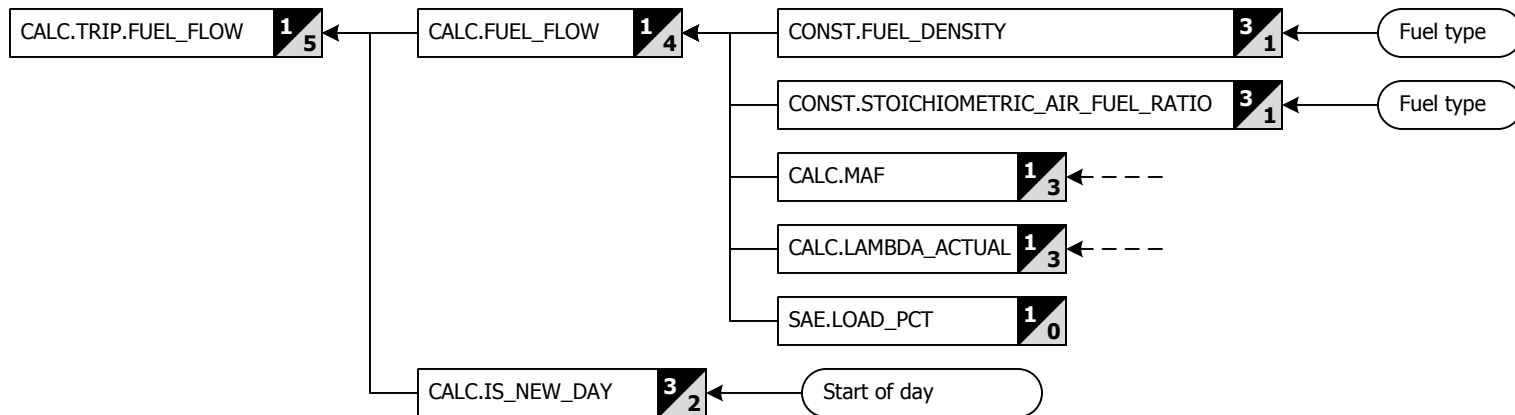

**CALC.TRIP.FUEL\_FLOW.AVG.{ABTPF}**

Average fuel flow rate for trip A, B, T, P, and F

**E:** gal(US)/h | gal(UK)/h <sup>3</sup>

**M:** l/h

Fuel

P3

<sup>3</sup> Output unit is controlled by the 'Volume' unit setting

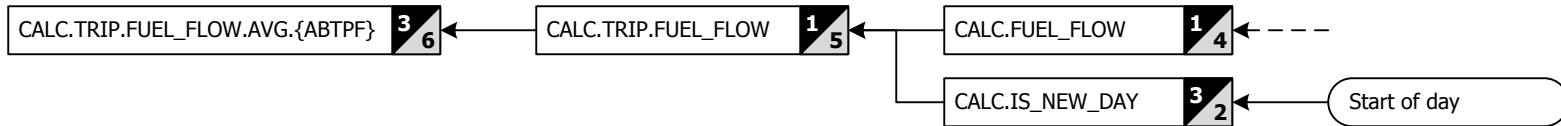

[Contents](#)

[Index](#)

[Categories](#)

**CALC.TRIP.FUEL\_FLOW.MAX.{ABTPF}**

Maximum fuel flow rate for trip A, B, T, P, and F

**E:** gal(US)/h | gal(UK)/h <sup>3</sup> **M:** l/h | Fuel | P3

<sup>3</sup> Output unit is controlled by the 'Volume' unit setting

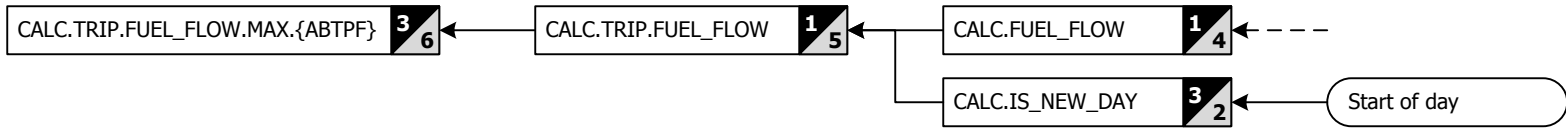



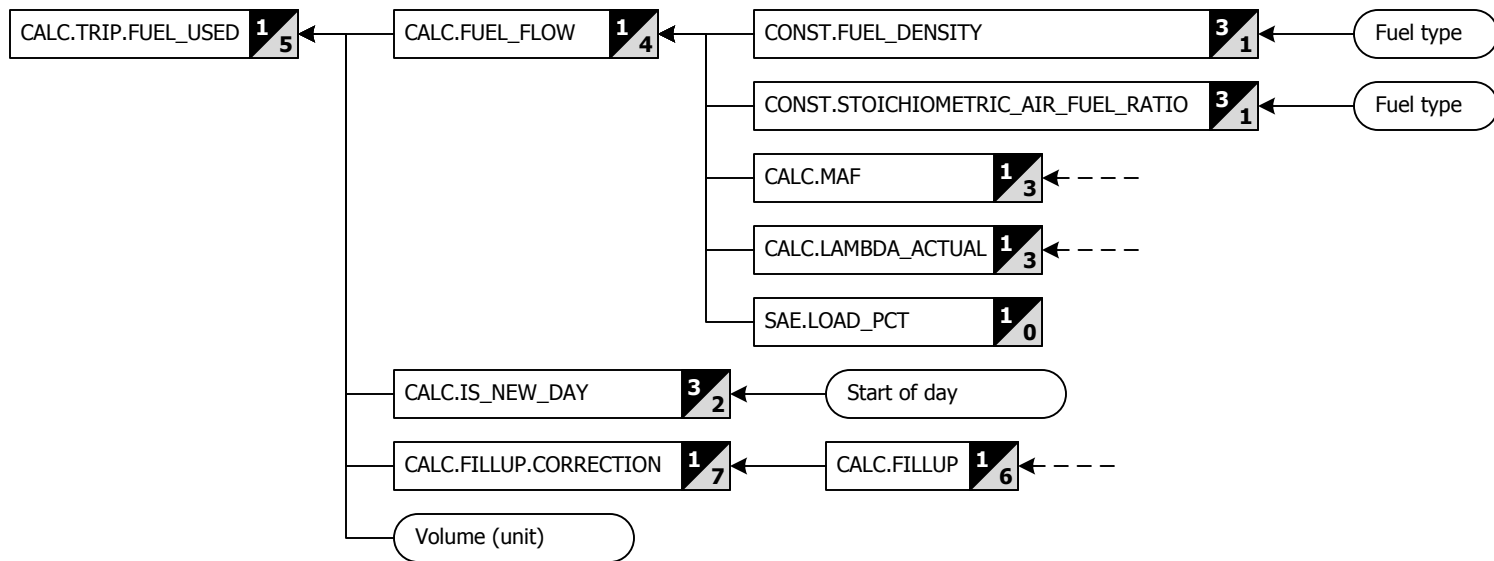

**3** Output unit is controlled by the 'Volume' unit setting

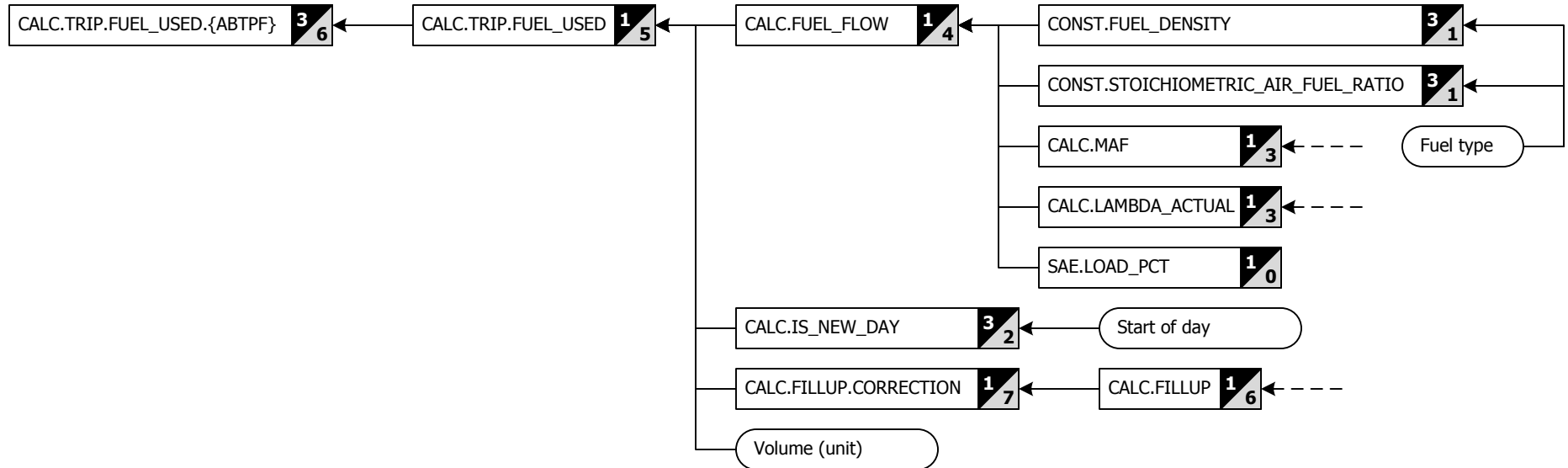

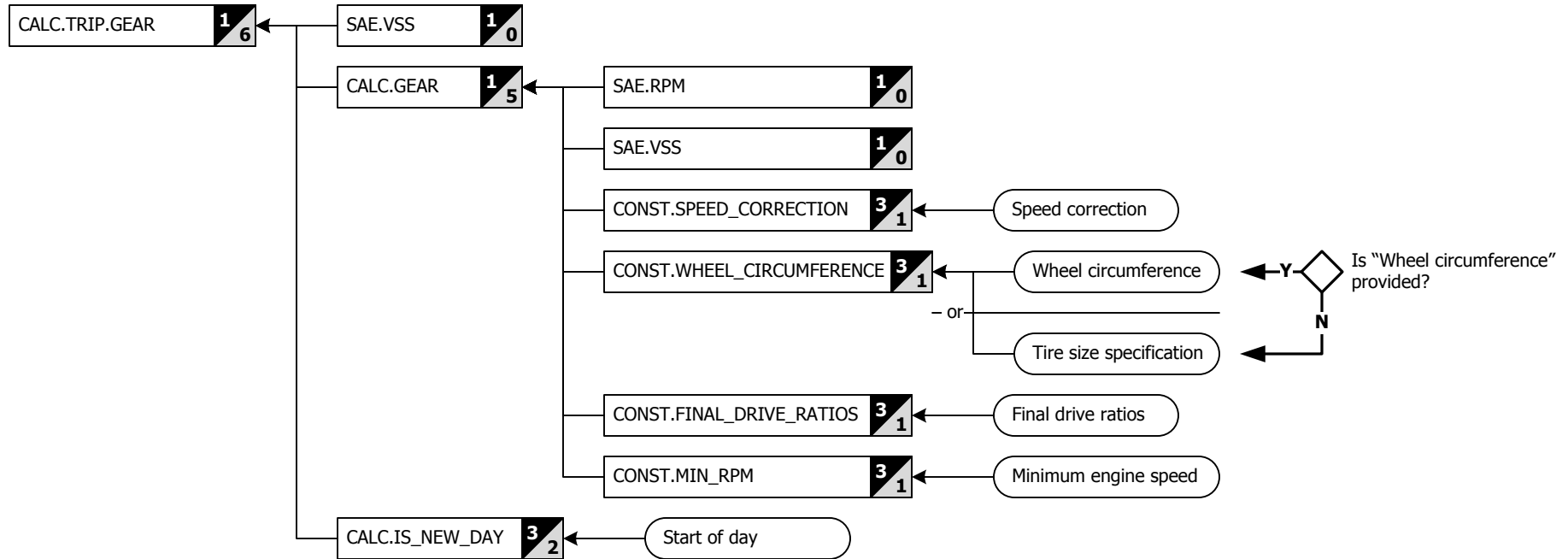

**CALC.TRIP.GEAR.{1..6}.DISTANCE\_PCT.{ABTPF}**

Percent distance travelled in each gear for trip A, B, T, P, and F

**E:** %

**M:** %

Transmission

P3

CALC.TRIP.GEAR.{1..6}.DISTANCE\_PCT.{ABTPF}

3  
7

CALC.TRIP.GEAR

1  
6

[Contents](#)

[Index](#)

[Categories](#)

**CALC.TRIP.GEAR.{1..6}.TIME\_PCT.{ABTPF}**

Percent time travelled in each gear for trip A, B, T, P, and F

**E:** %

**M:** %

Transmission

P3

CALC.TRIP.GEAR.{1..6}.TIME\_PCT.{ABTPF}

3  
7

CALC.TRIP.GEAR

1  
6

[Contents](#)

[Index](#)

[Categories](#)

**CALC.TRIP.GEAR.N.DISTANCE\_PCT.{ABTPF}**

Percent distance travelled in no gear for trip A, B, T, P, and F

**E:** %

**M:** %

Transmission

P3

CALC.TRIP.GEAR.N.DISTANCE\_PCT.{ABTPF}

3

7

CALC.TRIP.GEAR

1

6

[Contents](#)

[Index](#)

[Categories](#)

**CALC.TRIP.GEAR.N.TIME\_PCT.{ABTPF}**

Percent time travelled in no gear for trip A, B, T, P, and F

**E:** %

**M:** %

Transmission

P3

CALC.TRIP.GEAR.N.TIME\_PCT.{ABTPF}

3

7

CALC.TRIP.GEAR

1

6

[Contents](#)

[Index](#)

[Categories](#)

**CALC.TRIP.GEAR.WG.DISTANCE\_PCT.{ABTPF}**

Percent distance travelled in wrong gear for trip A, B, T, P, and F

**E:** %

**M:** %

Transmission

P3

CALC.TRIP.GEAR.WG.DISTANCE\_PCT.{ABTPF}

3  
7

CALC.TRIP.GEAR

1  
6

[Contents](#)

[Index](#)

[Categories](#)



**CALC.TRIP.GEAR.WG.TIME\_PCT.{ABTPF}**

Percent time travelled in wrong gear for trip A, B, T, P, and F

**E:** %

**M:** %

Transmission

P3

CALC.TRIP.GEAR.WG.TIME\_PCT.{ABTPF}

3

7

CALC.TRIP.GEAR

1

6

[Contents](#)

[Index](#)

[Categories](#)

**CALC.TRIP.POWER**

Engine power stats for trip computer

**E:** --**M:** --

System

P1

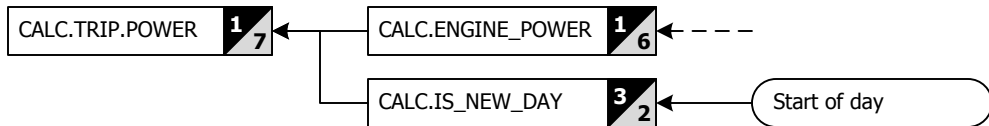
[Contents](#)[Index](#)[Categories](#)

**CALC.TRIP.POWER.MAX.{ABTPF}**

Maximum engine power for trip A, B, T, P, and F

**E:** hp**M:** kW | ps**4** Performance

P3

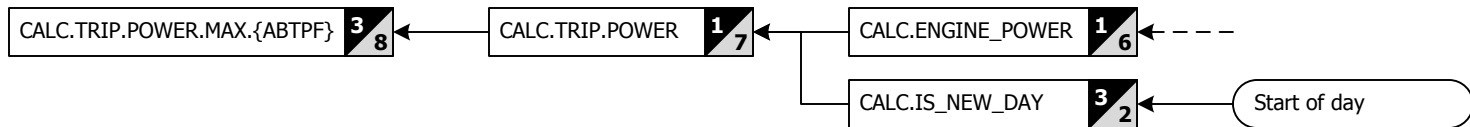
**4** Output unit is controlled by the 'Power' unit setting[Contents](#)[Index](#)[Categories](#)

**CALC.TRIP.RPM**

Engine speed stats for trip computer

**E:** --**M:** --

System

P1

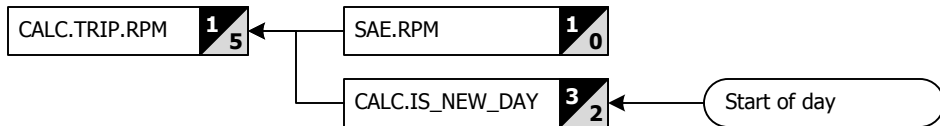
[Contents](#)[Index](#)[Categories](#)

**CALC.TRIP.RPM.MAX.{ABTPF}**

Maximum engine speed for trips A, B, T, P, and F

**E:** rpm

**M:** r/min

Speed

P3

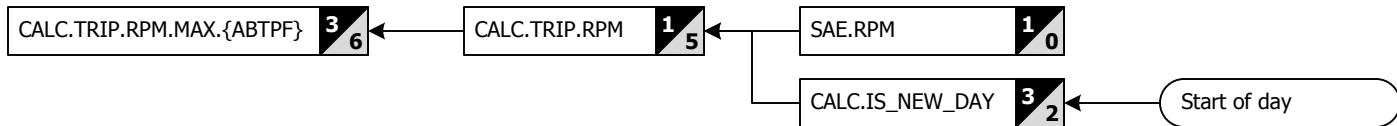

[Contents](#)

[Index](#)

[Categories](#)

**CALC.TRIP.SPEED**

Vehicle speed stats for the trip computer

**E:** --**M:** --

System

P1

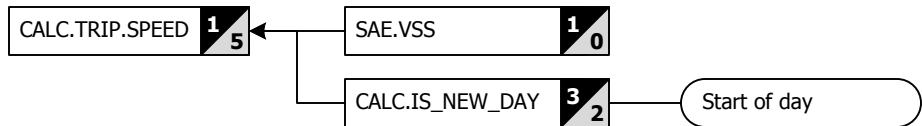
[Contents](#)[Index](#)[Categories](#)

**CALC.TRIP.SPEED.AVG\_NI.{ABTPF}**

Average vehicle speed (no idling) for trips A, B, T, P, and F

**E:** mph

**M:** km/h

Speed

P3

CALC.TRIP.SPEED.AVG\_NI.{ABTPF} **3**/**6**

CALC.TRIP.SPEED **1**/**5**

SAE.VSS **1**/**0**

CALC.IS\_NEW\_DAY **3**/**2**

Start of day

[Contents](#)

[Index](#)

[Categories](#)

**CALC.TRIP.SPEED.AVG\_WI.{ABTPF}**

Average vehicle speed (with idling) for trips A, B, T, P, and F

**E:** mph

**M:** km/h

Speed

P3

CALC.TRIP.SPEED.AVG\_WI.{ABTPF} **3**/**6**

CALC.TRIP.SPEED **1**/**5**

SAE.VSS **1**/**0**

CALC.IS\_NEW\_DAY **3**/**2**

Start of day

[Contents](#)

[Index](#)

[Categories](#)



**CALC.TRIP.SPEED.MAX.{ABTPF}**

Maximum vehicle speed for trips A, B, T, P, and F

**E:** mph

**M:** km/h

Speed

P3

CALC.TRIP.SPEED.MAX.{ABTPF} **3/6**

CALC.TRIP.SPEED **1/5**

SAE.VSS **1/0**

CALC.IS\_NEW\_DAY **3/2**

Start of day

[Contents](#)

[Index](#)

[Categories](#)

**CALC.TRIP.STOPS**

Number of stops stats for the trip computer

**E:** --**M:** --

System

P1

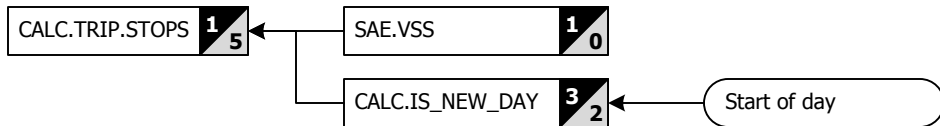
[Contents](#)[Index](#)[Categories](#)

**CALC.TRIP.STOPS.{ABTPF}**

Number of stops for trips A, B, T, P, and F

**E:** --

**M:** --

General

P3

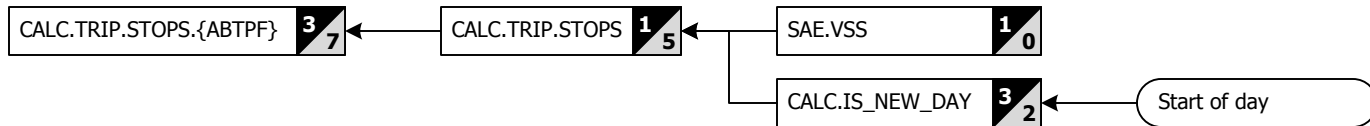

[Contents](#)

[Index](#)

[Categories](#)

**CALC.TRIP.TIME**

Time based stats for the trip computer

**E:** --**M:** --

System

P1

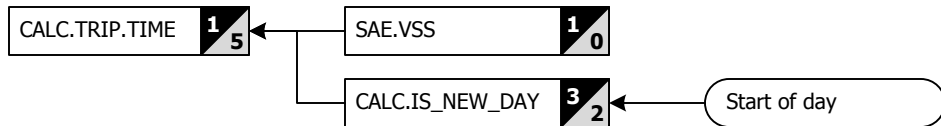
[Contents](#)[Index](#)[Categories](#)

**CALC.TRIP.TIME.DRIVE.{ABTPF}**

Drive time for trips A, B, T, P, and F

**E:** hh:mm

**M:** ms

Time

P3

CALC.TRIP.TIME.DRIVE.{ABTPF} **3/6**

CALC.TRIP.TIME **1/5**

SAE.VSS **1/0**

CALC.IS\_NEW\_DAY **3/2**

Start of day

[Contents](#)

[Index](#)

[Categories](#)

**CALC.TRIP.TIME.ELAPSED.{ABTPF}**

Elapsed time for trips A, B, T, P, and F

**E:** hh:mm

**M:** ms

Time

P3

CALC.TRIP.TIME.ELAPSED.{ABTPF} **3**/**6**

CALC.TRIP.TIME **1**/**5**

SAE.VSS **1**/**0**

CALC.IS\_NEW\_DAY **3**/**2**

Start of day

[Contents](#)

[Index](#)

[Categories](#)

**CALC.TRIP.TIME.IDLE.{ABTPF}**

Idle time for trips A, B, T, P, and F

**E:** hh:mm

**M:** ms

Time

P3

CALC.TRIP.TIME.IDLE.{ABTPF} **3/6**

CALC.TRIP.TIME **1/5**

SAE.VSS **1/0**

CALC.IS\_NEW\_DAY **3/2**

Start of day

[Contents](#)

[Index](#)

[Categories](#)

**CALC.TRIP.TIME.RUN.{ABTPF}**

Run time for trips A, B, T, P, and F

**E:** hh:mm

**M:** ms

Time

P3

CALC.TRIP.TIME.RUN.{ABTPF} **3**/**6**

CALC.TRIP.TIME **1**/**5**

SAE.VSS **1**/**0**

CALC.IS\_NEW\_DAY **3**/**2**

Start of day

[Contents](#)

[Index](#)

[Categories](#)



**CALC.TRIP.TIME.START.{ABTPF}**

Start time for trips A, B, T, P, and F

**E:** hh:mm**M:** ms

Time

P3

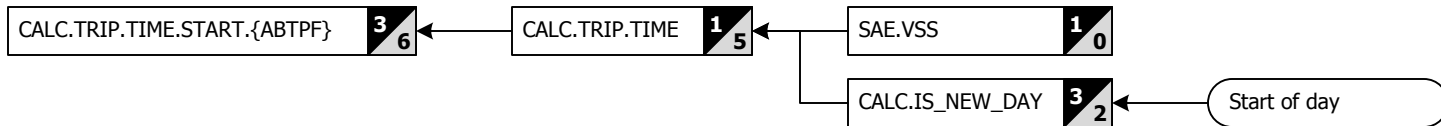
[Contents](#)[Index](#)[Categories](#)

## CALC.TRIP.TORQUE

Engine torque stats for the trip computer

E: --

M: --

System

P1

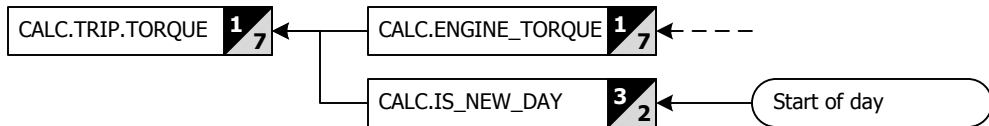

[Contents](#)

[Index](#)

[Categories](#)

**CALC.TRIP.TORQUE.MAX.{ABTPF}**

Maximum engine torque for trips A, B, T, P, and F

**E:** lb·ft

**M:** N·m | kg-f·m <sup>2</sup>

Performance

P3

<sup>2</sup> Output unit is controlled by the 'Torque' unit setting

CALC.TRIP.TORQUE.MAX.{ABTPF} <sup>3</sup>/<sub>8</sub>

CALC.TRIP.TORQUE <sup>1</sup>/<sub>7</sub>

CALC.ENGINE\_TORQUE <sup>1</sup>/<sub>7</sub>

CALC.IS\_NEW\_DAY <sup>3</sup>/<sub>2</sub>

Start of day

[Contents](#)

[Index](#)

[Categories](#)

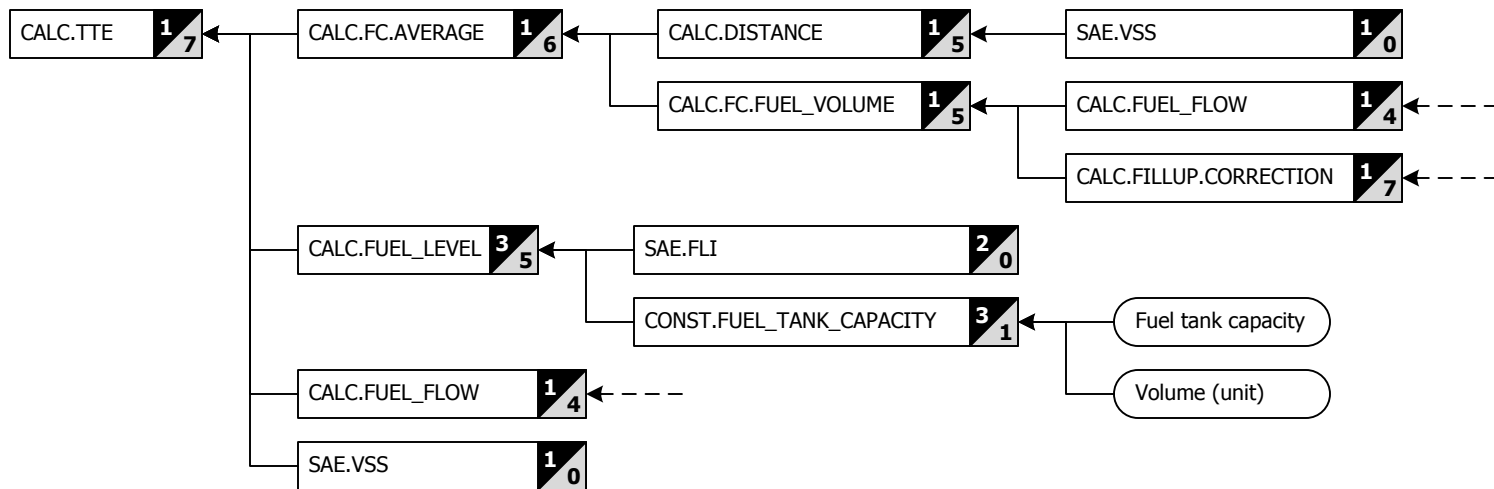

Uses average fuel consumption and fuel level to calculate the time to empty when the vehicle is moving. Uses fuel flow and fuel level when vehicle is stationary.

**CALC.VACUUM**

Intake vacuum pressure

**E:** inHg**M:** kPa

Airflow

P1

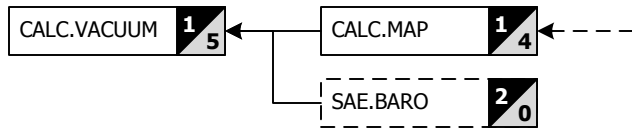

This PID is similar to CALC.BOOST\_PRESSURE but reports values in units used when measuring vacuum.

[Contents](#)[Index](#)[Categories](#)

**CALC.VSS\_C**

Corrected vehicle speed

**E:** mph

**M:** km/h

Speed

P1

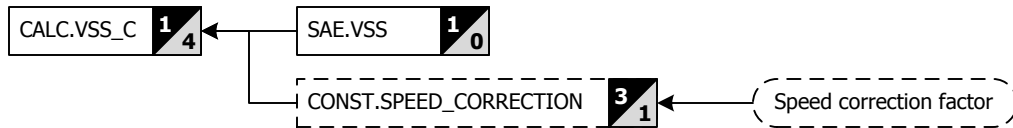

$VSS\_C = VSS * correction\_factor$

[Contents](#)

[Index](#)

[Categories](#)

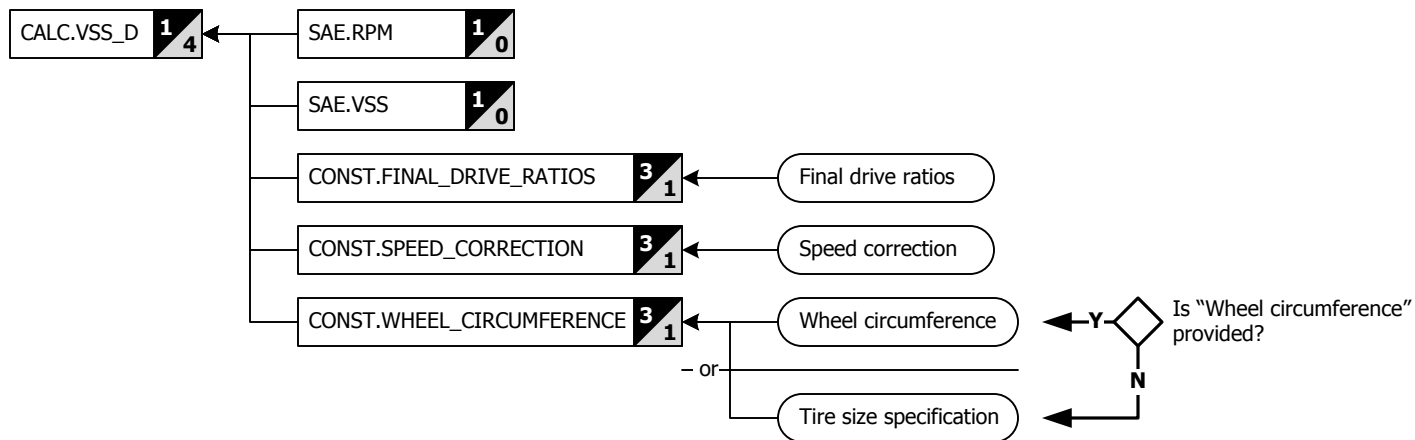

**EXPERIMENTAL:**

Uses VSS, RPM, WHEEL\_CIRCUMFERENCE, and FINAL\_DRIVE\_RATIOS to first determine the current gear, then uses the current gear, RPM, WHEEL\_CIRCUMFERENCE, and FINAL\_DRIVE\_RATIO to calculate a more accurate vehicle speed.

**CONST.ADDITIONAL\_WEIGHT**

Validated 'Additional weight' setting

**E:** lb

**M:** kg

System

P3

CONST.ADDITIONAL\_WEIGHT

**3**  
**1**

Additional weight

**Contents**

**Index**

**Categories**



**CONST.CURB\_WEIGHT**

Validated 'Curb weight' setting

**E:** lb

**M:** kg

System

P3

CONST.CURB\_WEIGHT

3  
1

Curb weight

[Contents](#)

[Index](#)

[Categories](#)

**CONST.DRAG\_COEFFICIENT**

Validated 'Drag coefficient' setting

**E:** --

**M:** --

System

P3

CONST.DRAG\_COEFFICIENT

**3**  
**1**

Drag coefficient

[Contents](#)

[Index](#)

[Categories](#)

**CONST.ENGINE\_DISPLACEMENT**

Validate 'Engine displacement' setting

**E:** in<sup>3</sup>

**M:** l

System

P3

CONST.ENGINE\_DISPLACEMENT

**3**  
**1**

Engine displacement

[Contents](#)

[Index](#)

[Categories](#)

**CONST.FINAL\_DRIVE\_RATIOS**

Validated 'Final drive ratios' setting

**E:** --

**M:** --

System

P3

CONST.FINAL\_DRIVE\_RATIOS

**3**  
**1**

Final drive ratios

[Contents](#)

[Index](#)

[Categories](#)

**CONST.FRONTAL\_AREA**

Validated 'Frontal area' setting

**E:** ft<sup>2</sup>

**M:** m<sup>2</sup>

System

P3

CONST.FRONTAL\_AREA

**3**

**1**

Frontal area

**Contents**

**Index**

**Categories**

**CONST.FRP\_PID**

Fuel rail pressure PID used by the system

**E:** --

**M:** --

System

P3

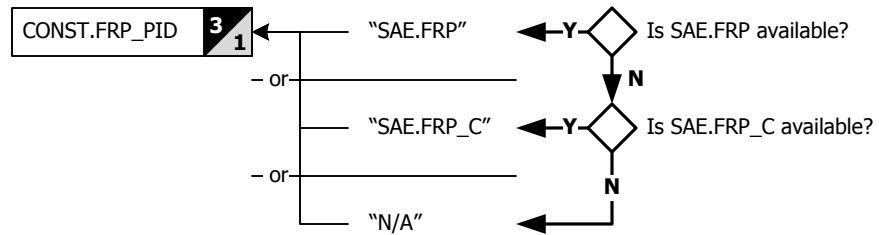

[Contents](#)

[Index](#)

[Categories](#)

**CONST.FUEL\_CO2\_CONTENT**

Carbon dioxide content for current fuel type

**E:** lb/gal(US) | lb/gal(UK)

**3**

**M:** kg/l

System

P3

CONST.FUEL\_CO2\_CONTENT

**3**

**1**

Fuel type

[Contents](#)

[Index](#)

[Categories](#)

## CONST.FUEL\_DENSITY

Fuel density of current fuel type

**E:** lb/gal(US) | lb/gal(UK) **3** **M:** g/l

System

P3

CONST.FUEL\_DENSITY

**3**  
**1**

Fuel type

[Contents](#)

[Index](#)

[Categories](#)



## CONST.FUEL\_TANK\_CAPACITY

Validated 'Fuel tank capacity' setting

**E:** gal(US) | gal(UK) **3** **M:** 1

System

P3

CONST.FUEL\_TANK\_CAPACITY

**3**  
**1**

Fuel tank capacity

Volume (unit)

[Contents](#)

[Index](#)

[Categories](#)

**CONST.LAMBDA\_ACTUAL\_PID**

Lambda PID used by the system

**E:** --**M:** --

System

P3

CONST.LAMBDA\_PID\_ACTUAL **3**/**1**

Lambda (actual) PID

- or

"SAE.WO2Sxy[.B].LAMBDA"

One of a possible 32 PIDs  
x = sensor bank [1..4],  
y = sensor number [1..4]  
.B = series B PIDs

- or

"N/A"

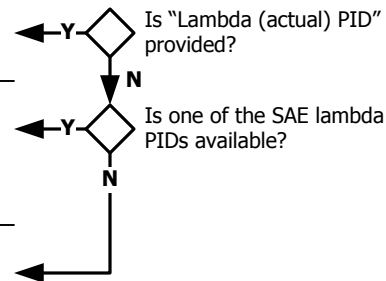
[Contents](#)[Index](#)[Categories](#)

**CONST.LAMBDA\_CMDANDED\_PID**

Commanded Lambda PID used by the system

**E:** --

**M:** --

System

P3

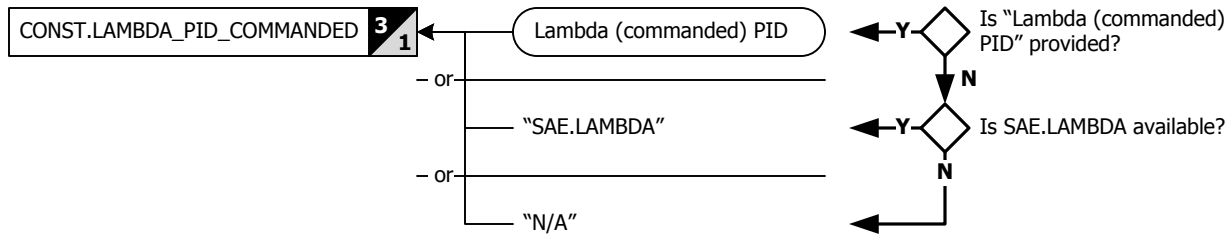

[Contents](#)

[Index](#)

[Categories](#)

**CONST.MAF\_PID**

Mass air flow PID used by the system

E: --

M: --

System

P3

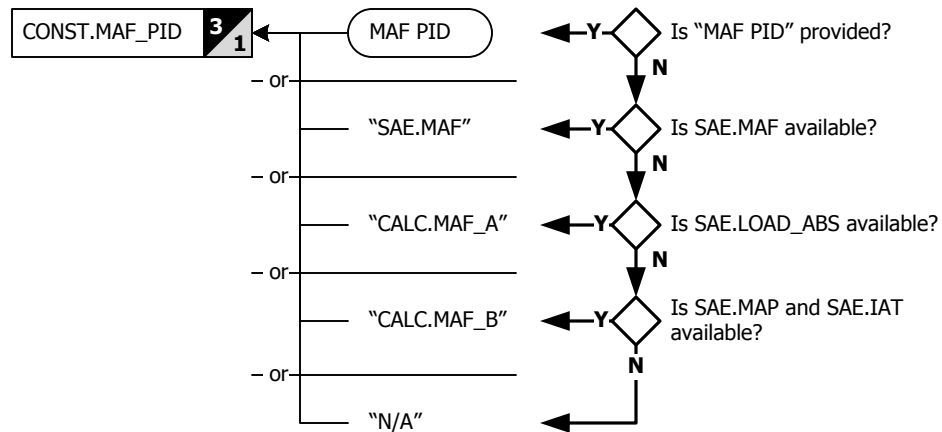
[Contents](#)[Index](#)[Categories](#)

**CONST.MAP\_PID**

Manifold absolute pressure PID used by the system

**E:** --**M:** --

System

P3

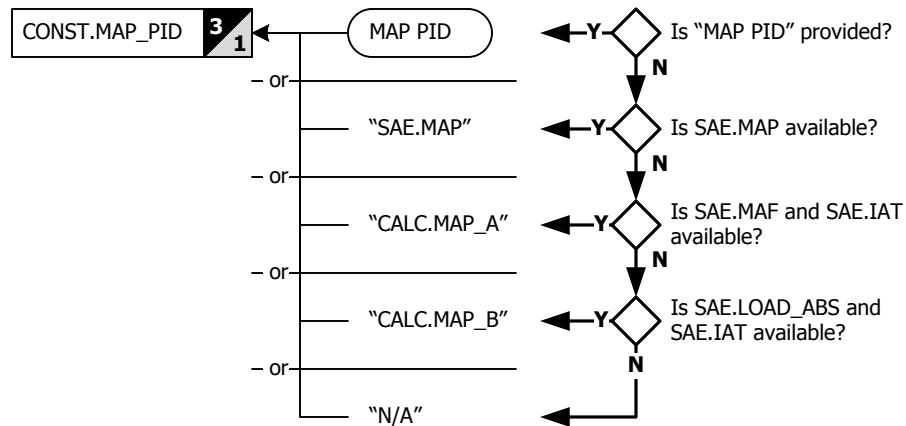
[Contents](#)[Index](#)[Categories](#)

**CONST.MAX\_RPM**

Validated 'Maximum engine speed' setting

**E:** rpm

**M:** r/min

System

P3

CONST.MAX\_RPM

**3**  
**1**

Maximum engine speed

[Contents](#)

[Index](#)

[Categories](#)

**CONST.MIN\_RPM**

Validated "Minimum engine speed" setting

**E:** rpm

**M:** r/min

System

P3

CONST.MIN\_RPM

**3**  
**1**

Minimum engine speed

[Contents](#)

[Index](#)

[Categories](#)

**CONST.SHIFT\_RPM**

Validated 'Shift point' setting

**E:** rpm

**M:** r/min

System

P3

CONST.SHIFT\_RPM

**3**  
**1**

Shift point

**Contents**

**Index**

**Categories**



## CONST.SPEED\_CORRECTION

Validated 'Speed correction factor' setting

**E:** %

**M:** coefficient

System

P3

CONST.SPEED\_CORRECTION

**3**  
**1**

Speed correction

[Contents](#)

[Index](#)

[Categories](#)

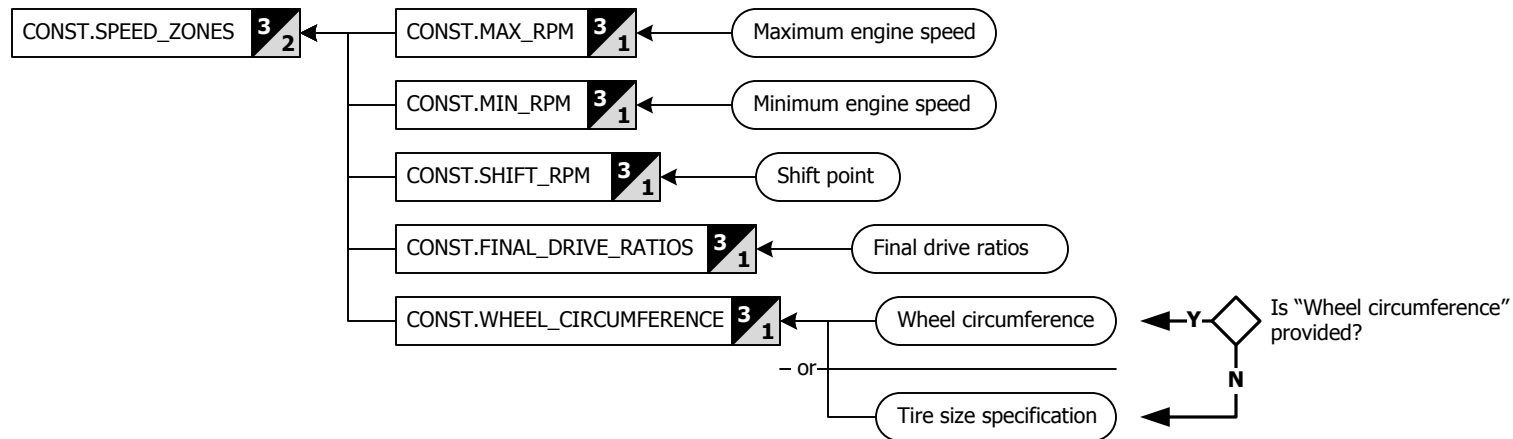

**CONST.SPEED\_ZONES.{1..6}.MAX\_SPEED**

Maximum speed for each gear

**E:** mph**M:** km/h

System

P3

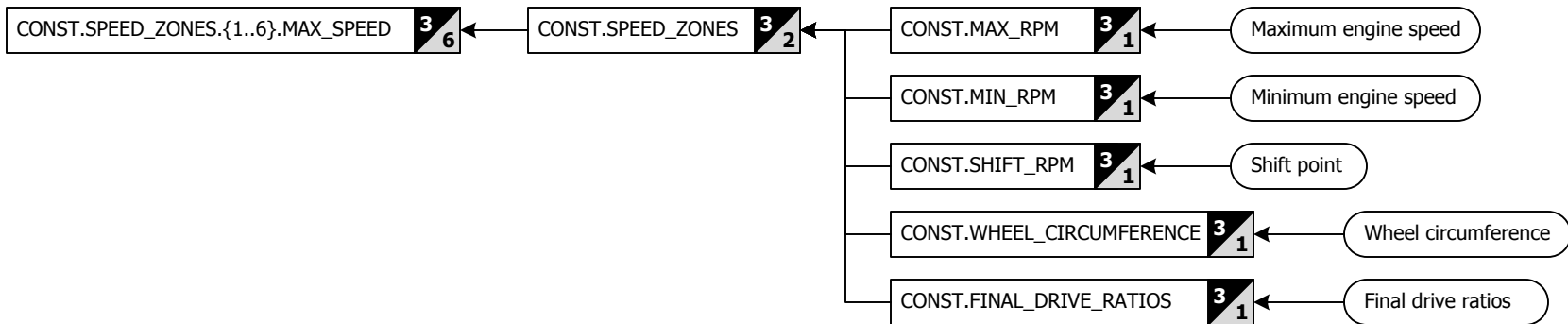
[Contents](#)[Index](#)[Categories](#)

**CONST.SPEED.ZONES.{1..6}.MIN\_SPEED**

Minimum speed for each gear

**E:** mph**M:** km/h

System

P3

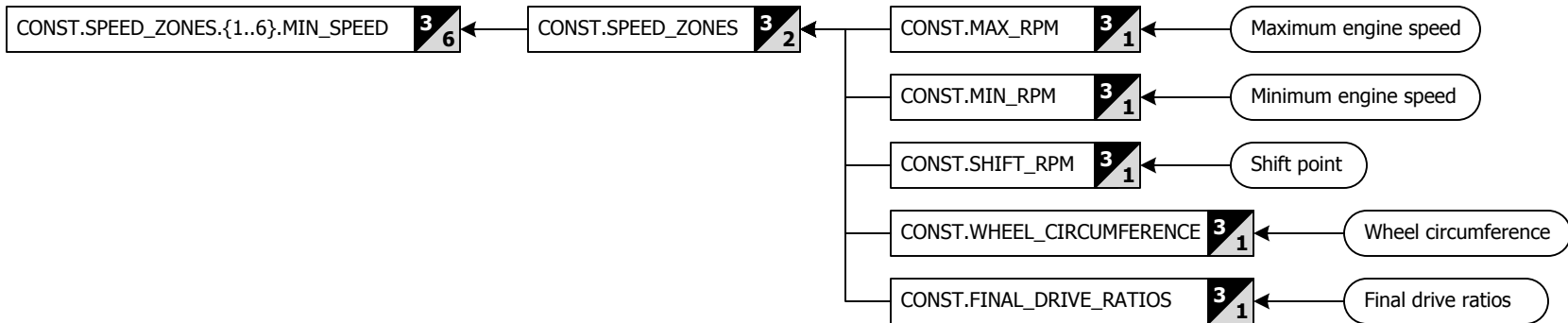
[Contents](#)[Index](#)[Categories](#)

**CONST.SPEED\_ZONES.{1..6}.SHIFT\_SPEED**

Ideal shift speed for each gear

**E:** mph**M:** km/h

System

P3

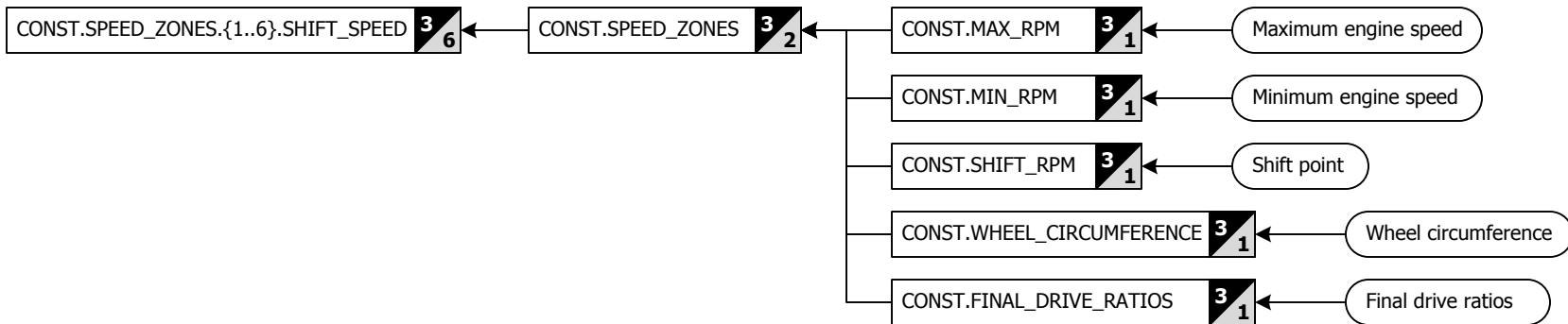
[Contents](#)[Index](#)[Categories](#)

**CONST.STOICHIOMETRIC\_AIR\_FUEL\_RATIO**

Stoichiometric air/fuel ratio of current fuel type

**E:** --

**M:** --

System

P3

CONST.STOICHIOMETRIC\_AIR\_FUEL\_RATIO

**3**  
**1**

Fuel type

[Contents](#)

[Index](#)

[Categories](#)

**CONST.TIRE\_RESISTANCE**

Validated 'Tire rolling resistance coefficient' setting

**E:** --

**M:** --

System

P3

CONST.TIRE\_RESISTANCE

3  
1

Tire rolling resistance coefficient

[Contents](#)

[Index](#)

[Categories](#)

**CONST.VOLUMETRIC\_EFFICIENCY**

Validated 'Volumetric efficiency' setting

**E:** %

**M:** coefficient

System

P3

CONST.VOLUMETRIC\_EFFICIENCY

3

1

Volumetric efficiency

[Contents](#)

[Index](#)

[Categories](#)



## CONST.WHEEL\_CIRCUMFERENCE

Wheel circumference used by the system

**E:** r/mile

**M:** r/km

System

P3

CONST.WHEEL\_CIRCUMFERENCE **3**  
**1**

Wheel circumference

- or -

Tire size specification

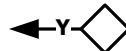

Is "Wheel circumference" provided?

[Contents](#)

[Index](#)

[Categories](#)